

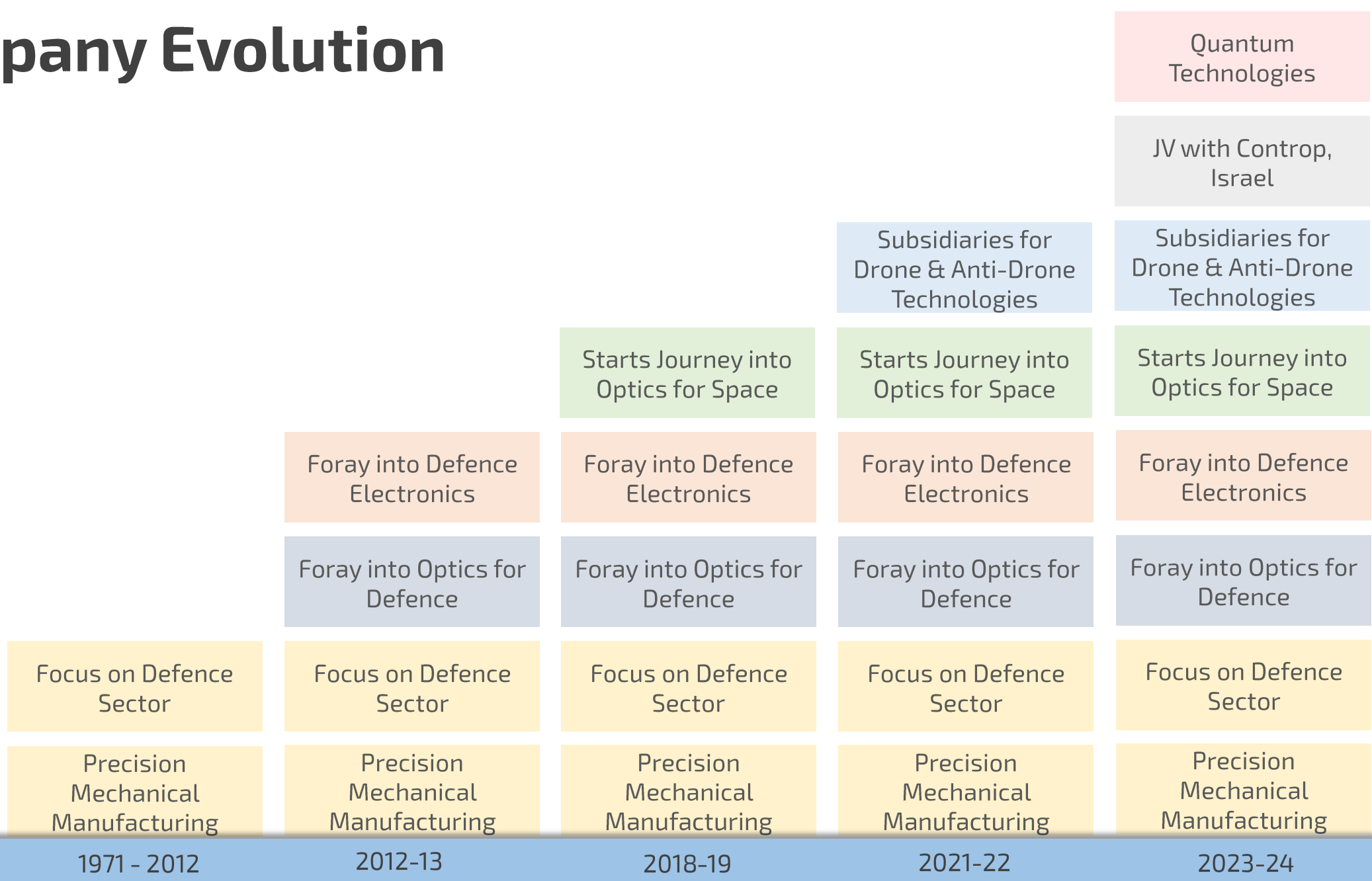

# Paras Defence & Space Technologies Limited

*Premier Defence and Space Engineering Company*

# Company Evolution



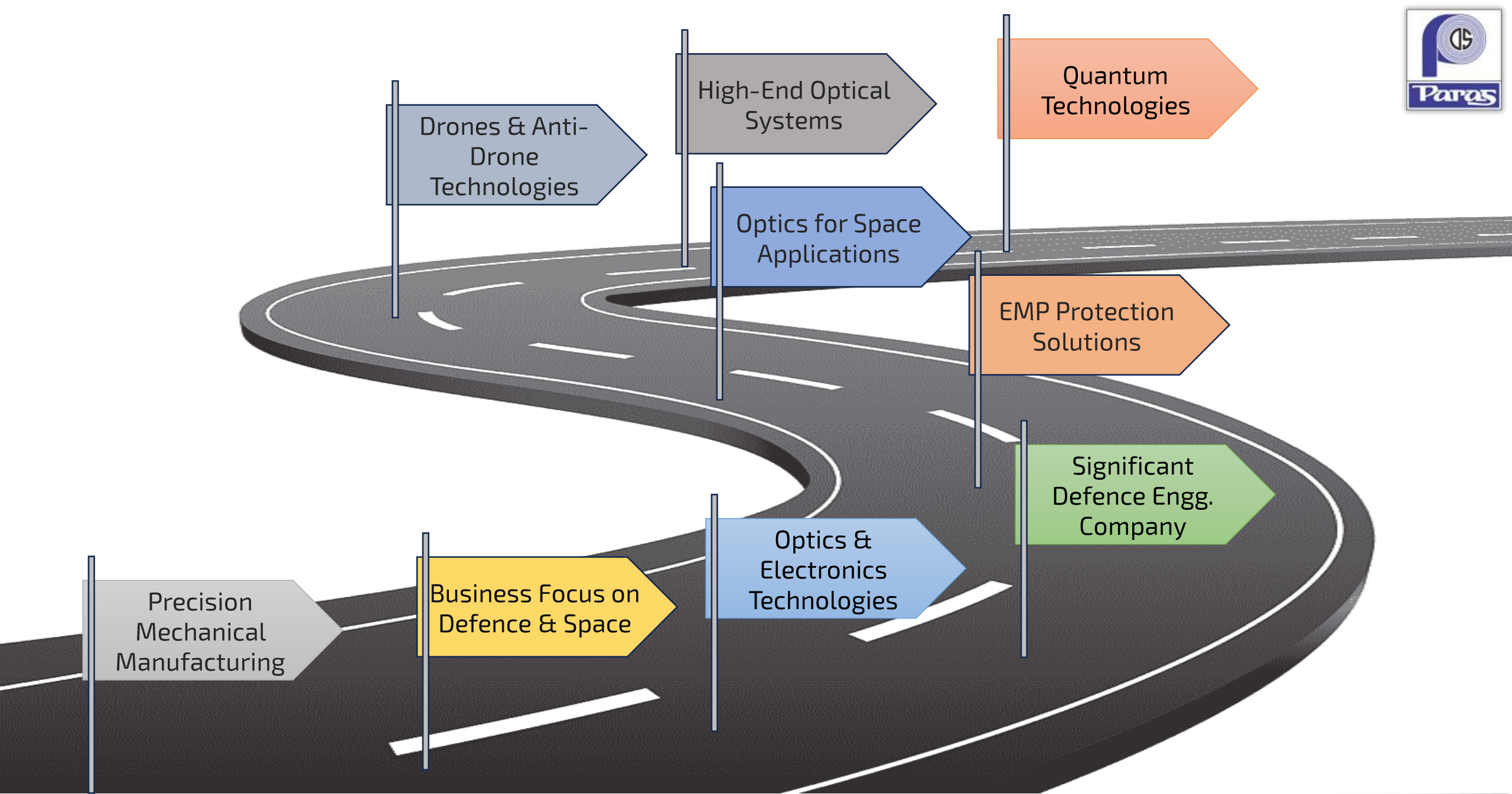

# Subsidiaries of Paras Defence

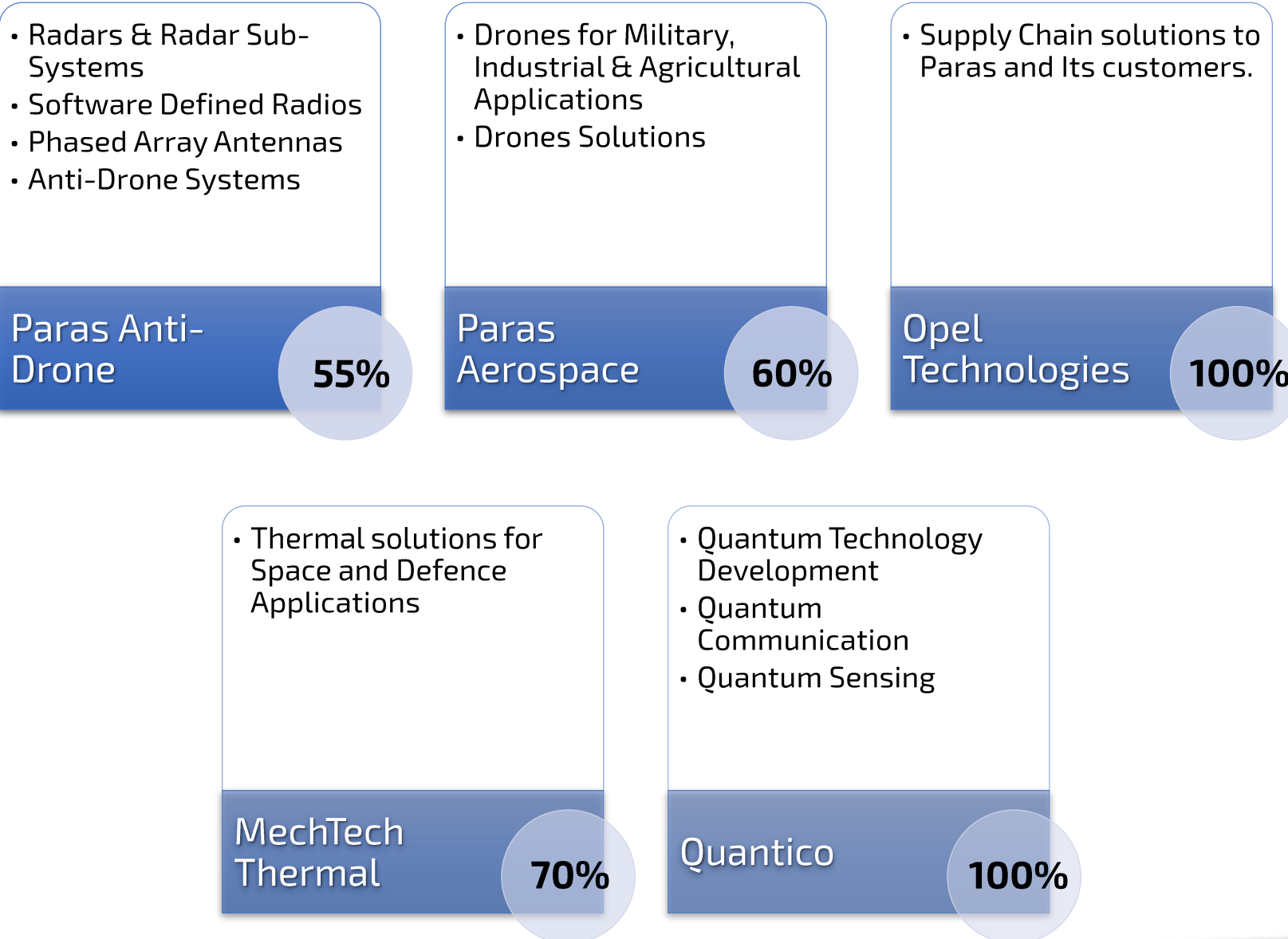



## **India's No. 1 High-End Optical Systems Company**

Paras aims to become India's No. 1 High-End Optical Systems Company catering to the Domestic as well as World Market, through in-house R&D & global partnerships.

## **India's No. 1 ElectroMagnetics Company**

Paras aspires to offer turnkey solutions for ElectroMagnetic Protection covering EM Pulse, Anechoic Chambers & Antenna Test Ranges amongst others, not just for Domestic but for World Market

## **India's No. 1 Anti-Drone Company**

We strive to become India's No. 1 company developing and producing cutting-edge Anti-Drone Technologies including Radars, Software Defined Radios, Phased Arrays & Advanced Antennas etc.

## **Work on Future Technologies**

We would always want to stay ahead of competition by Innovation and working on Future Technologies by in-house R&D and collaborative Technology Development



# Force Behind the Growth of Paras Defence

## High-End Optical Systems

It's **exclusive in-house capabilities** of Design, System Engineering, state-of-the-art manufacturing, integration, testing and qualification makes Paras Defence **India's Leading Company for High-End Optical Systems.**

Paras Defence delivers these systems for various platforms such as Land, Armoured Vehicles, Naval Vessels, Avionics, UAVs & Drones and Space Missions, **differentiating us as India's Leading and World's significant company** into High-End Optical Systems for **Defence & Space Applications**, which is estimated to be few Thousand Crores (INR) Market Annually.

# Leading Products



# Submarine Periscope



*Image only for application reference*



Only Company in the whole Asia Pacific to develop and mfg. Submarine Periscope

World Class Proven Performance

Paras is delivering 1 Periscope every 3 Months and aiming for more...

Huge Opportunities on New as well as Existing Platforms with current funnel of 24+ Nos

Domestic & World Market opportunities indicate a yearly revenue of 300+ Cr.



# Hyper-Spectral Cameras for Defence & Space

*Image only for application reference*



Only Indian Pvt. Company to have developed and mfg. a Hyper-Spectral Camera for Defence & Space

Will be jointly launched by DRDO & ISRO in this FY

100% Designed, Developed and Manufactured in India by Paras

Long term opportunities as Hyper-Spectral Camera is a part of almost every Optical Space Mission

Hyper-Spectral Cameras will have varied applications incl. Defence, Medical, Agricultural etc.

# ElectroMagnetic Protection Solutions

*Image only for application reference*

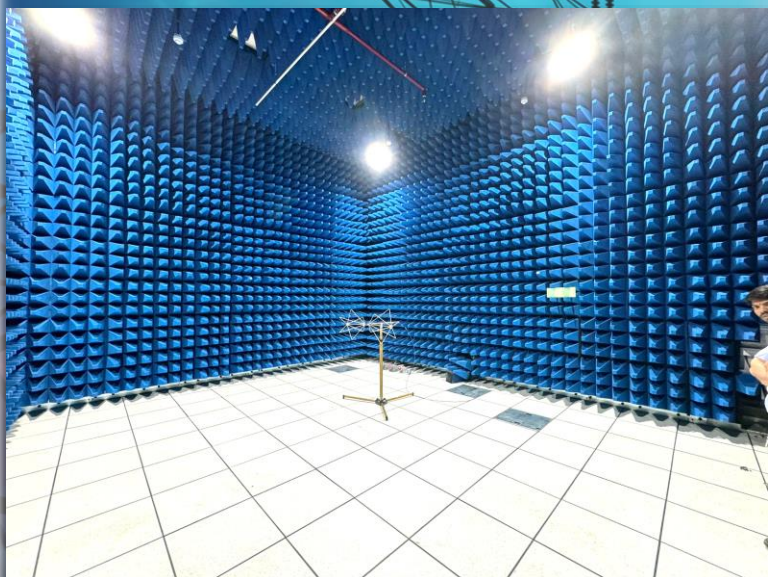

Only Indian Company to offer Turnkey ElectroMagnetic (EM) Protection Solutions

Certified & Field Proven High Performance EM Pulse (EMP) Protection for Radiated & Conducted Threats

Turnkey Semi/Full Anechoic Chambers for EM Measurements along with ancillary services

We have collaborated with Global Leader to offer High Performance Antenna Test Range Solutions

Huge Business Potential with Funnel of 350+ Cr. Over the next 2 to 3 Years

# Border Defence System



First of its kind Border Defence System to prevent the frontline Soldiers from facing the enemy firing

Rugged Field Trialed System comprising of Surveillance Unit, Weapon Unit & Control System

100% Design, Developed & Manufactured by Paras in collaboration with DRDO

Advanced trials are in progress and performance is found satisfactory

Huge Domestic Business Potential with Funnel of 4000 Nos. over the next 5 to 7 Years + Global Market

*Image only for application reference*

# Optical Systems

*Image only for application reference*

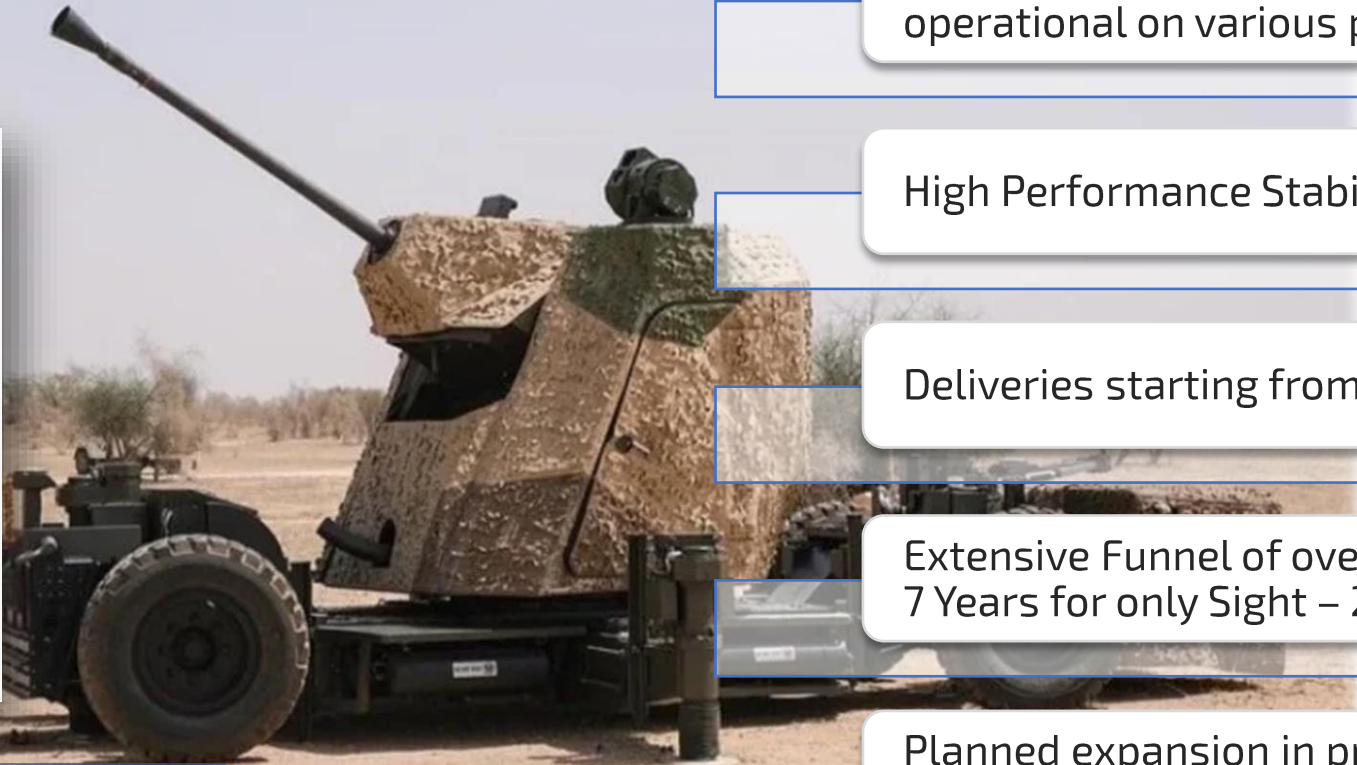

Field Proven World Class EO/IR Optical Systems operational on various platforms worldwide

High Performance Stabilised Optical System

Deliveries starting from 2025

Extensive Funnel of over 5000 Units in the next 3 to 7 Years for only Sight – 25HD

Planned expansion in product portfolio promises more opportunities in Domestic and World Markets

In Partnership with Controp Precision Technologies, Israel

# Optical Cameras for Drones & UAVs

*Image only for application reference*



Only Indian Company to manufacture Cameras for Drones and UAVs

Exceptional Optical Performance with Un-cooled IR & Inertial Stabilization

Very Low Weight & Power Requirements making it suitable for multiple platforms

Made in India with very high Indigenous Content in collaboration with Controp, Israel

High Business Potential with growing Drone Market in India for Military, Industrial & Agricultural Drones

# Avionic Suite for Saras – MK-II

*Image only for application reference*

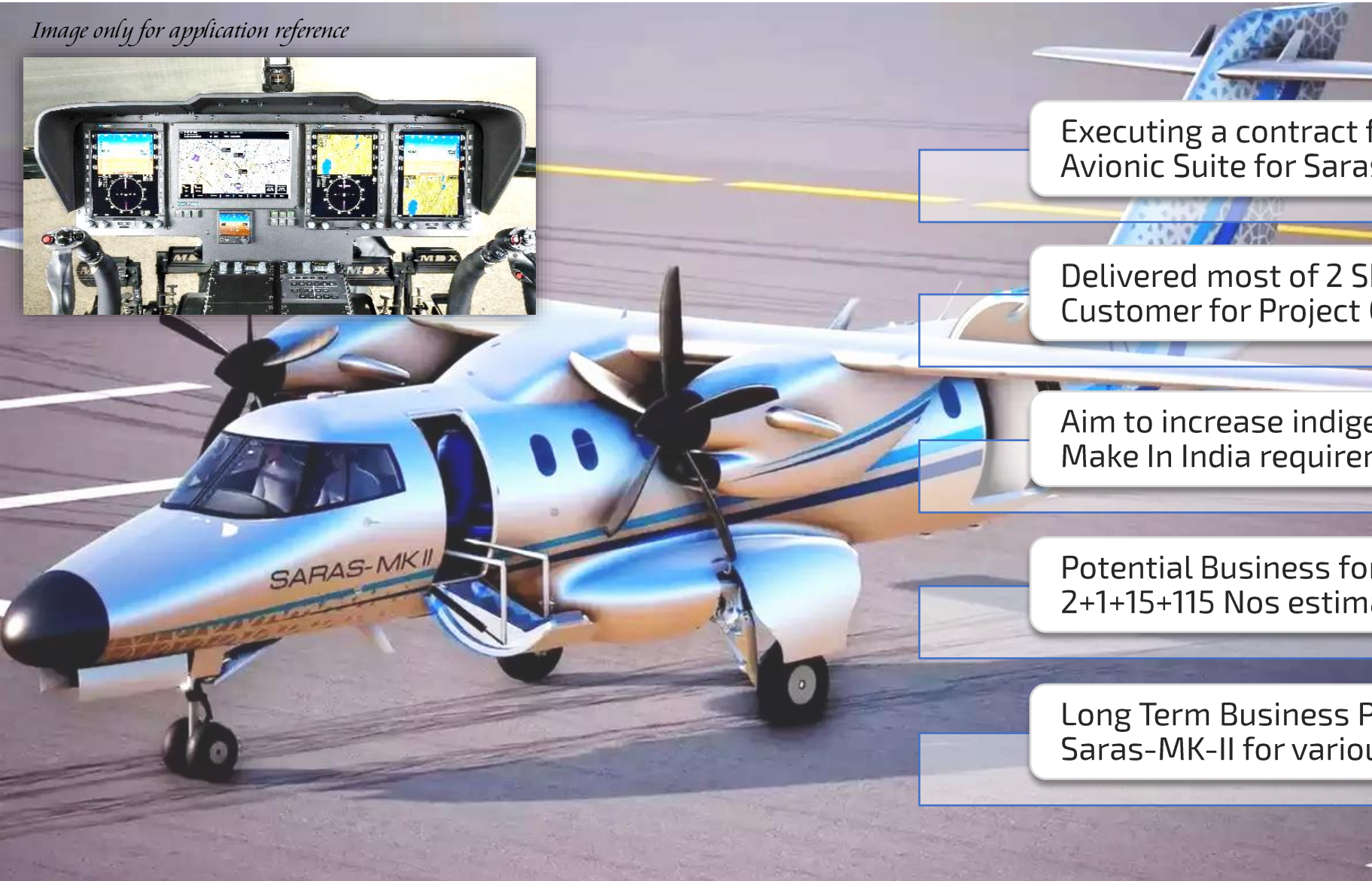

Executing a contract for Complete Glass Cockpit / Avionic Suite for Saras – MK-II Aircraft Platform

Delivered most of 2 Shipsets and working with Customer for Project Completion

Aim to increase indigenous content in-line with Make In India requirements for future requirements

Potential Business for Saras-MK-II would include 2+1+15+115 Nos estimated in the next 5 to 7 Years

Long Term Business Potential extending beyond Saras-MK-II for various similar platforms & more

# Revolutionary Products by our Subsidiaries

*that may change the landscape of our Future*



# Flagship Anti-Drone Products



## Dexter 20

All Integrated Drone Detection  
& Jamming System

Range: 1.5+ KMs

All Integrated Drone Detection &  
Jamming System

Frequency: 400MHz to 6GHz

Directional & Omnidirectional  
Jamming

Adaptive IQ Waveform Jamming



## Terminator

High Performance Drone  
Jamming Gun/System

Range: 1.5+ KMs

High Performance Directional  
Jamming System

Frequency: GPS L1, L2, L5, 2.4GHz,  
5.2GHz, 5.8GHz

Plug & Play Modular Design

Man-Portable with Weight < 6Kgs



# Range of Cutting-Edge Products



**Hydra & Sky Sense**  
Drone Detection Systems



**AeroBlast**  
Drone Jamming System



**AirLink-DMR**  
Tactical Communication System

# Developments in Paras Anti-Drone

*Image only for application reference*

RF & Microwave Custom Developments

Advanced Phased Arrays

Next Generation Software Defined Radio

Complex Antenna Systems

Futuristic Counter UAV Technologies

# Certified Agri-Drone

*Image only for application reference*



One of India's most cost-effective and dependable drone platform for Agricultural Applications

Two Models certified by DGCA and are being deployed for designated applications by customer

High Accuracy Design ensures Safe and predictable performance on the field

100% Designed, Developed & Manufactured in India

Huge Business Potential with many states in India coming up with their requirements

# World of Opportunities



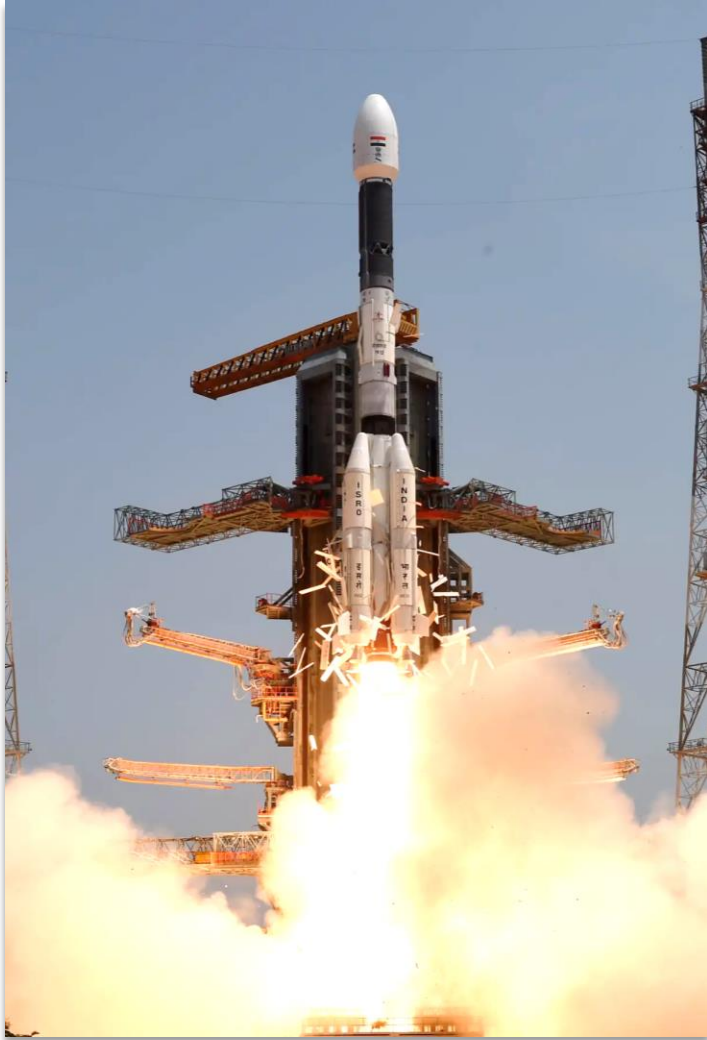

**Optical Systems for Space Programs**



**Airborne Optical Systems**



**Future Technologies**

# Space Programs





# Recent Updates on Opportunities in Space

EDITION IN ▾ | MUMBAI 30°C

## THE TIMES OF INDIA

**India** | Saving Our Stripes | Times Evoke | Maharashtra | Delhi | Karnataka | Tamil Nadu | Telangana | ...

NEWS / INDIA NEWS / CCS 'Approves Launch Of 52 Spy Satellites For...

**TRENDING** | Mahadev Betting App Owner | Goa Weather | Ajit Pawar | New UPI Transad | < | >

## CCS 'approves launch of 52 spy satellites for Rs 27,000 crore to boost space surveillance

Surendra Singh / TNN / Oct 12, 2024, 01:20 IST

SHARE | | | FOLLOW US

Paras Defence is the Only Indian Private Company which has all-round capability for Design, System Engineering, Manufacturing, Integrate, Test & Space Qualify Optical Systems for Space Programs and is working towards having significant workshare in the above!

**Hindustan Times** @100

hi 31°C

s 2024 | 2024 US Elections | **Crick** | HT Premium <sup>NEW</sup> | Loan ₹10 Lakh

ba Siddique | Win iPhone 15 | Videos | Photos | Web Stories | Sports | Delhi News

### Exclusive: CCS clears launch of 52 surveillance satellites

By [Shishir Gupta](#) X

Oct 11, 2024 08:32 AM IST

# Space Programs



*Image only for application reference*



Complete Optical Missions for Space

High Resolution Hyperspectral Camera for ISRO, Pvt. Companies & Export

Sub-Meter Resolution Optical Camera

Optical Payloads for Oceanography

Optical Payloads for Resource Management



# Space Programs



*Image only for application reference*

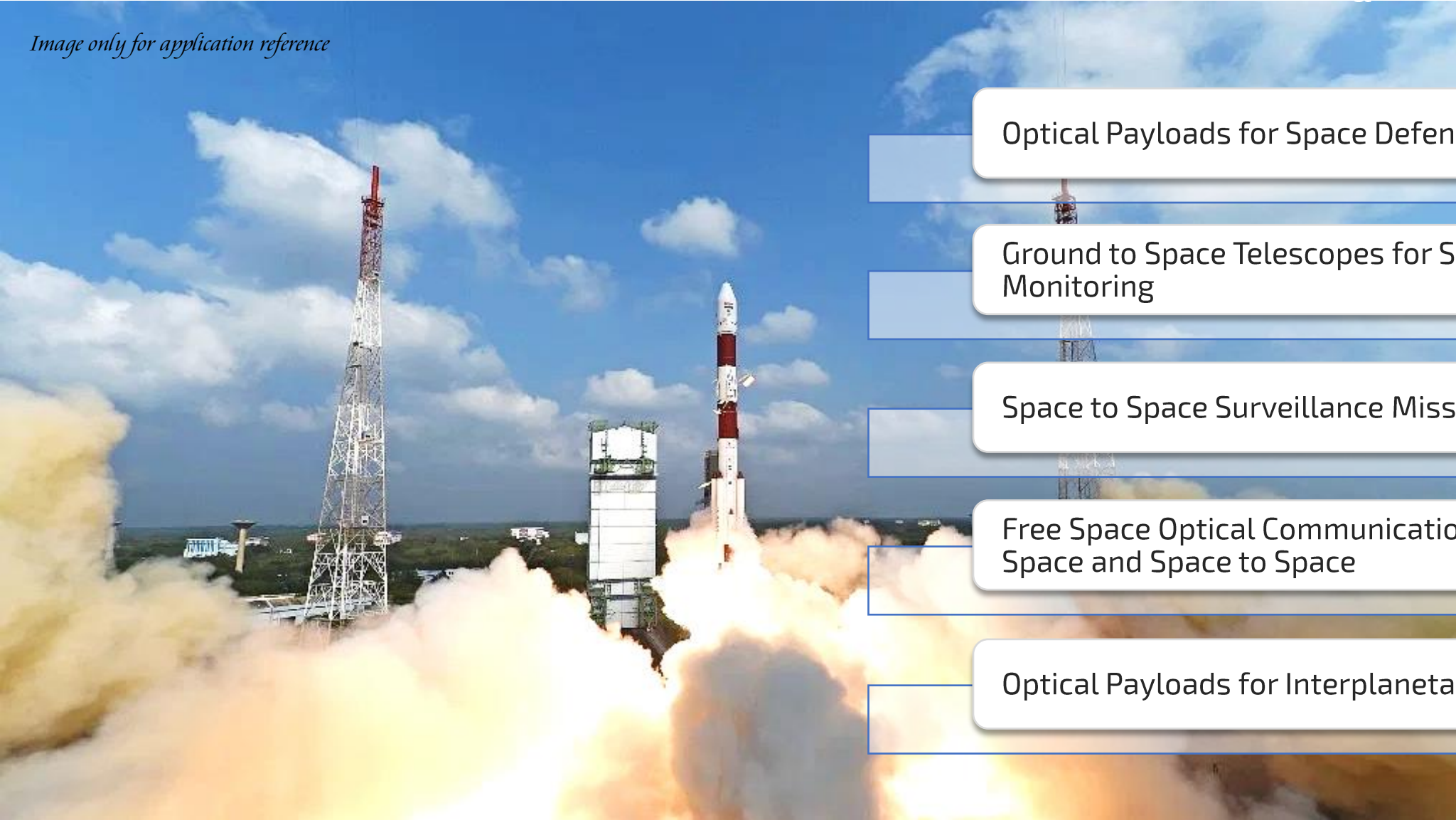

Optical Payloads for Space Defence

Ground to Space Telescopes for Space Debris Monitoring

Space to Space Surveillance Missions

Free Space Optical Communication from Gnd to Space and Space to Space

Optical Payloads for Interplanetary Missions

# Airborne Optical Systems



# Airborne Optical Systems



*Image only for application reference*

Developing Advanced Optical Systems for Airborne Applications in collaboration with our Customers

IRST – Infra-Red Search & Tracking System

Optical Camera Systems for Combat Aircrafts

High Performance Optical Systems for Medium/High Altitude Drones

Paras aims to become India's first company to develop and mfg. High End Airborne Payloads

# Future Technologies



# Quantum Technologies



*Image only for application reference*

Tread in Quantum Communications & Quantum Sensing

Prowess in Design of Optical & Electronic Systems, helps Paras to enter in Quantum Technologies

Currently building team and exploring right technologies as our first steps into Quantum World

Near-term to Mid-term Opportunities in the area of Quantum Sensing

Mid-term to Long-term Opportunities in the area of Quantum Communication

# High Power Laser Systems

First  
Company  
in India

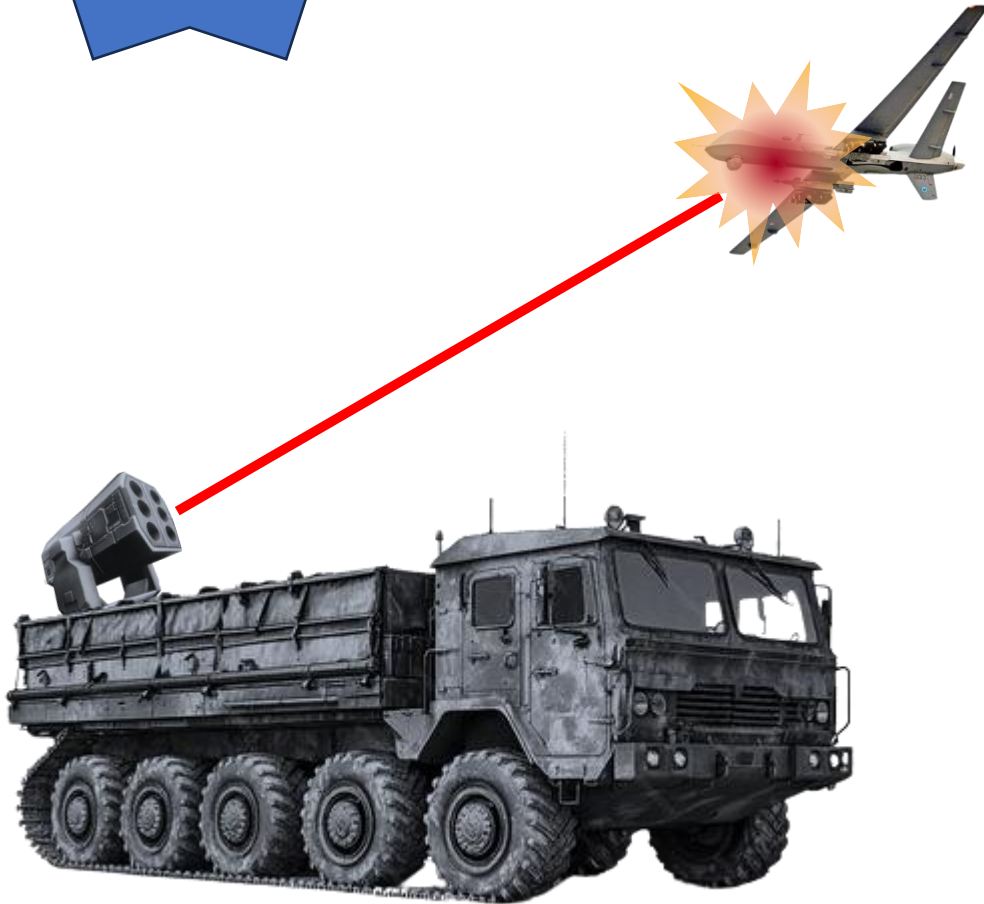

High Power Laser as a defence against Hostile Aerial Platforms such as Drones, Missiles & Aircrafts

Ground to Air and Ground to Space Applications

Air to Air and Space to Space Applications

Designed, Developed & Manufactured in India with High Efficient Optical Design by Paras

Addressable Market of approx. 25000 Crores



# About Us

Looking at a brighter Tomorrow

# Company at a Glance



**Wide Range  
of Products**



**Strong Team  
of 600+**



**World Class  
Quality**



**Innovation &  
R&D Centric**



**World Class  
Manufacturing  
Setup**



**Heritage of  
Defence &  
Space  
Programs**



# Exceptional Capabilities

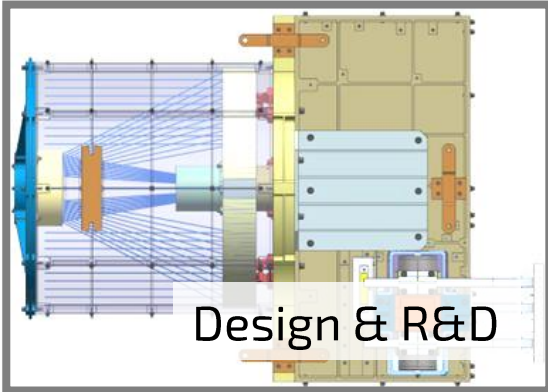

Design & R&D



Manufacturing



Integration



Test & Validation

- Optronic System Design
- Opto-Mech. Design
- Optical Design
- Electronic System Design
- Embedded System Design
- Electronic H/W Design
- Software Development
- ElectroMagnetic Design
- RF/Microwave Design
- Antenna Design
- Mechanical Design

- Infra-Red Lenses
- Optical Mirrors
- Optical Domes
- Optical Gratings
- Flowformed Tubes
- Titanium Assemblies
- Mech. Racks & Consoles
- Cold Plates
- Doors & Hatches
- Airvents & Waveguides
- Wiring Harnesses

- Submarine Periscope
- Border Defence Systems
- Hyper-Spectral Cameras
- Optical Systems
- Command/Control Consoles
- Control Systems
- High Performance PCs
- Rugged Displays
- Anti-Drone Systems
- Software Defined Radios
- Antenna Systems

- Physical Metrology
- Optical Metrology
- MTF Test Setup
- Electronic Test Setup
- Electrical Test Setup
- Environmental Test Setup
- High Pressure Test Setup
- Design Validation Tools
- RF Test Setup
- Antenna Test Setup
- Electromagnetic Test Setup

JV with  
Controp  
Precision  
Technologies  
Ltd., Israel

World's leading  
exclusive EO/IR  
company

**CONTROP**  
*Turning Vision Into Reality*

Paras has formed a JV with world's leading exclusive EO/IR company to manufacture world class EO/IR Systems in India (Under Make In India), for various platform including Drones.

**CP** **CONTROP** **PARAS**

JV Company of Controp Precision Technologies, Israel & Paras Defence & Space Technologies Ltd., India

# Widest Range of Optical Payloads

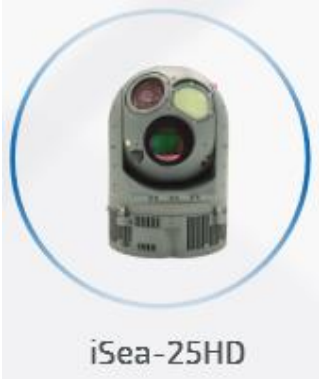

iSea-25HD



iSea-30HD



iSea-50HD



iSky-50HD



iSky-30HD



SIGHT-10E



SPEED-MR



SPEED-LR



SPEED-ER



TORNADO-ER



SIGHT-25E



SIGHT-25HD

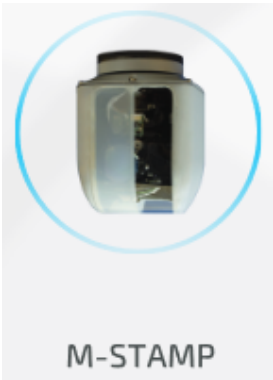

M-STAMP

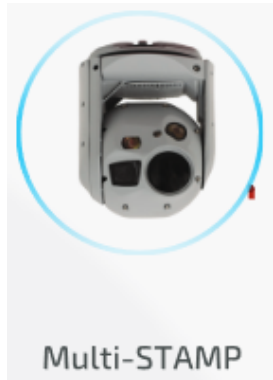

Multi-STAMP

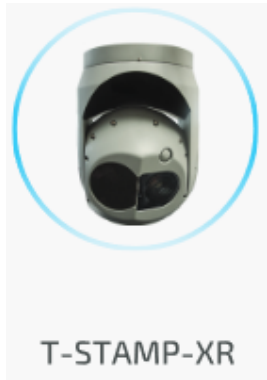

T-STAMP-XR



T-STAMP-XED



T-STAMP-XD



SIGHT-50HD

# Management Team

## Board of Directors



**Sharad Shah**  
Chairman



**Munjal Shah**  
Managing Director



**Shilpa Mahajan**  
Director

## Independent Directors & Company Secretary



**M.M. Handa**  
Independent Director



**Dr. Hina Gokhale**  
Independent Director



**Suresh Katyal**  
Independent Director



**Jajvalya Raghavan**  
Company Secretary

## KMP Directors



**Anish Mehta**  
Director: Bus. Dev.



**Harsh Bhansali**  
CFO



**Amit Mahajan**  
Director: Tech. & R&D



**Ami Shah**  
V.P. HR

## India's Best Optics Team



**Krishna Murthy**  
Ex-ISRO



**MV Rajashekhar**  
Ex-BEL



**Bharat Yelkur**  
Sr. Vice President



**S.Somashaker**  
Ex-ISRO



**R. Rajagopal**  
Sr. Vice President



**N. Saravanan**  
Sr. Vice President

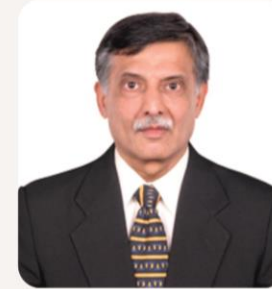

**K. Natarajan**  
Sr. Vice President



**Dr. Padmanabham**  
Ex-BDL

## Vice Presidents



**G.S. Ravichandar**  
Ex-BEL



**D. Ramakantha**  
Ex-BEL



**A.R. Bodhe**  
Industry Expert



**Yellamanda Y**  
Ex-BEL



# Locations

Sales & Marketing, Customer Interface, Post Sales Co-ordination

**New Delhi**

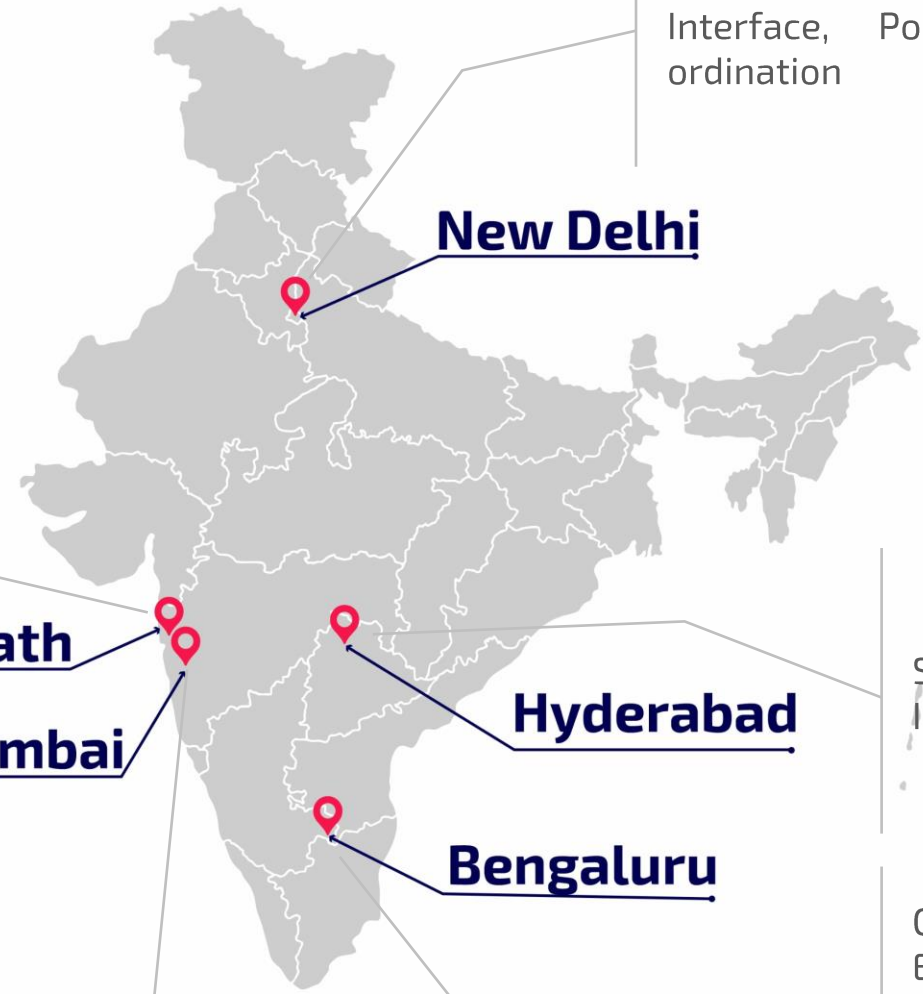

Heavy Engineering Mfg., Mechanical System Integration, Test Facilities

**Ambernath**

**Navi Mumbai**

**Hyderabad**

Sales & Marketing, Customer Interface, Post Sales Support

**Bengaluru**

Optics Mfg, Opto-Mech Integration, Electronics D&E, System Integration, Directors & Corporate Departments

Optics Design, Advanced Electronics System Design, Sales & Marketing, Projects & Customer Interface, After Sales Support

# Prestigious Customers



# Govt. Customers



Indian Ordnance Factories



Defence R&D Organisation



Bharat Electronics



ISRO



Goa Shipyard Limited



Mazagon Dock Limited



Hindustan Shipyard Limited



Garden Reach Shipbuilders & Engineers Ltd.



Cochin Shipyard Limited



BrahMos Aerospace Pvt. Ltd.



Bharat Dynamics Ltd.



Department of Atomic Energy



Electronics Corporation of India Ltd.



Society for Applied Microwave Electronics Engineering & Research



National Aerospace Laboratory



National Physical Laboratory of India



Indian Institute of Astrophysics



Hindustan Aeronautics Ltd.



# Private Customers



Godrej & Boyce Mfg. Co. Ltd.



Tata Power



Larsen & Toubro



Tata Consultancy Services



Alpha Design Technologies Pvt. Ltd.



Astra Rafael Comsys Pvt. Ltd.



Solar Industries India Ltd.



Premier Explosives Ltd.



Tonbo Imaging

# International Customers



Rafael Advanced Defense  
Systems Ltd.



Israel Aerospace Industries



Elbit Systems



Controp



Tae Young Optics Co. Ltd.



Chaban Group

# Financial Overview





# Consolidated Yearly Financial Performance

## Revenue from Operations

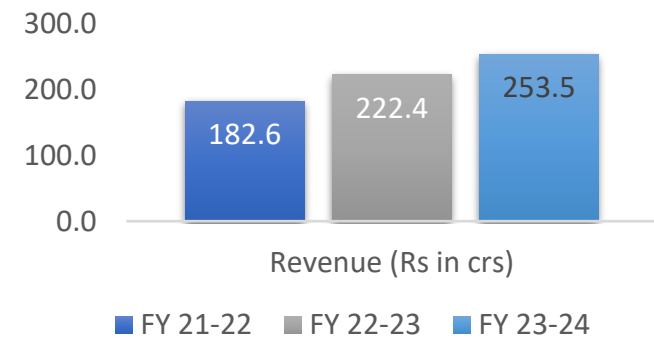

## EBITDA

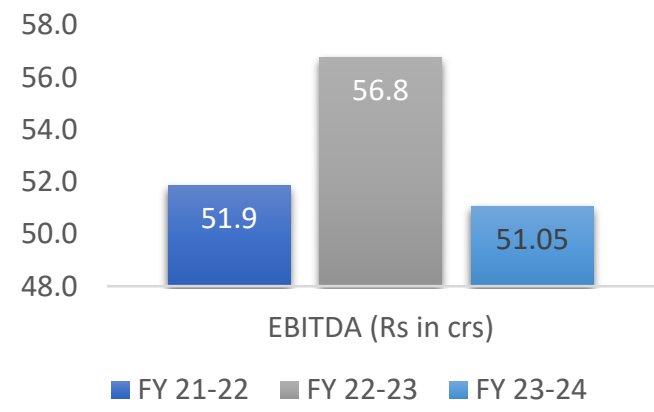

## Profit after Tax

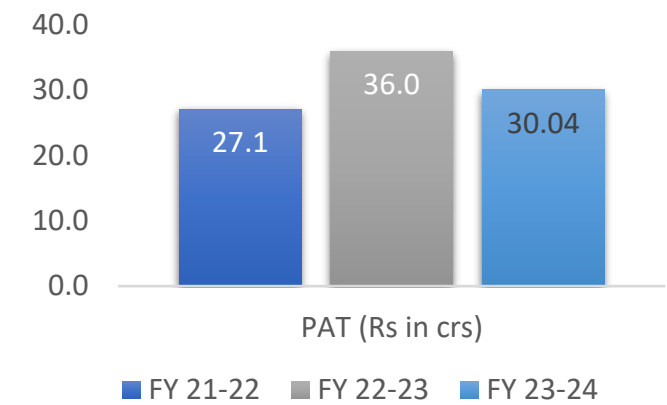

**Guidance for FY25 & FY26:**  
We aim to grow our revenues by 40-50% and maintain or slightly better our profitability as compared to previous years.

# Standalone Q3-FY25 Financial Performance

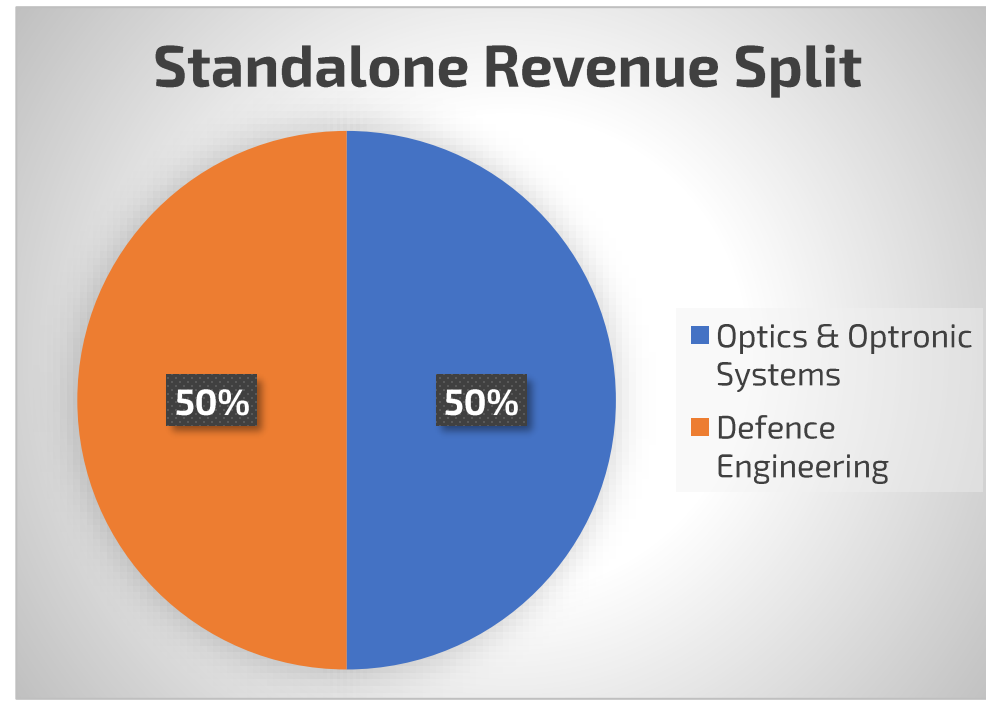
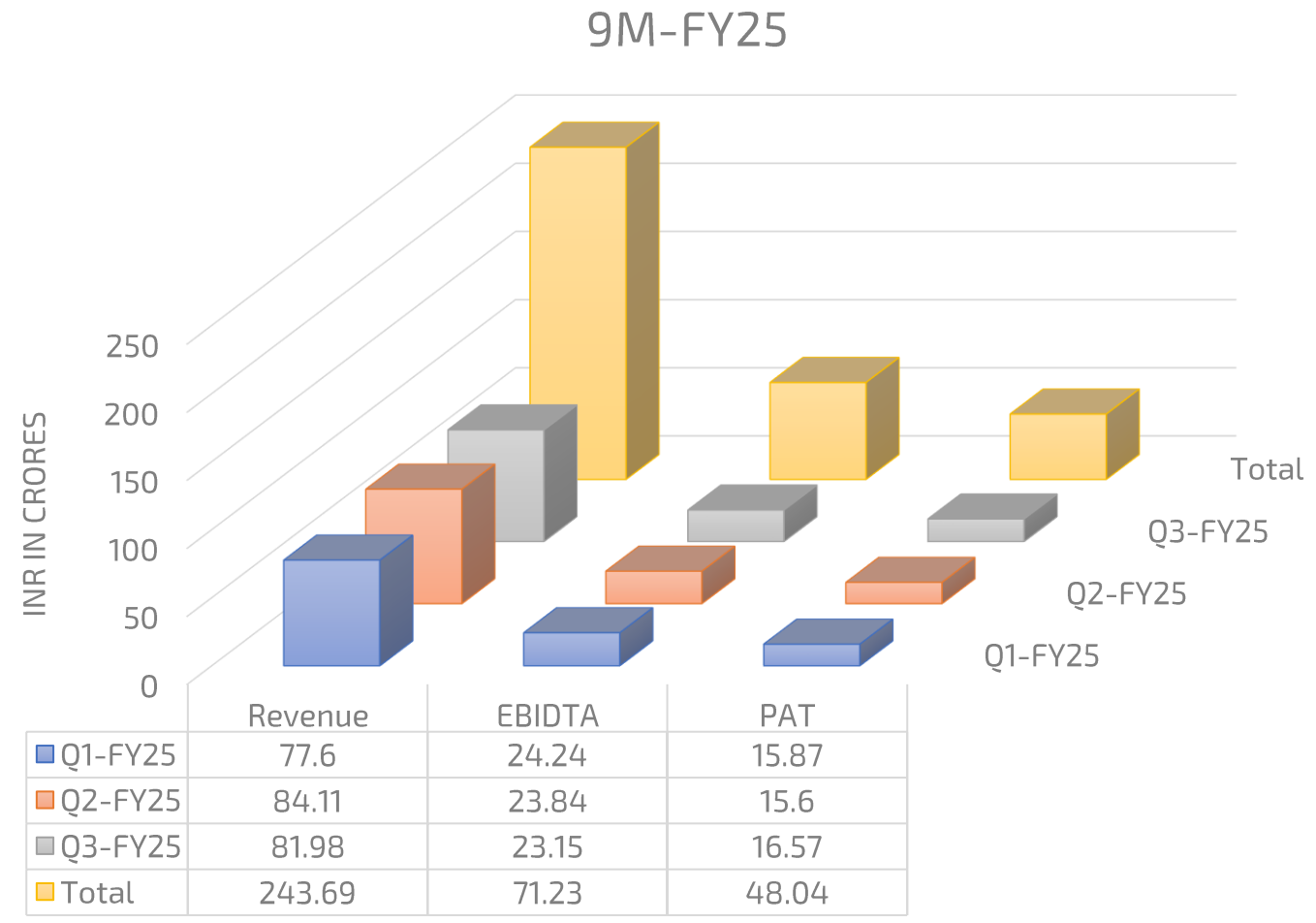

# Consolidated Q3-FY25 Financial Performance

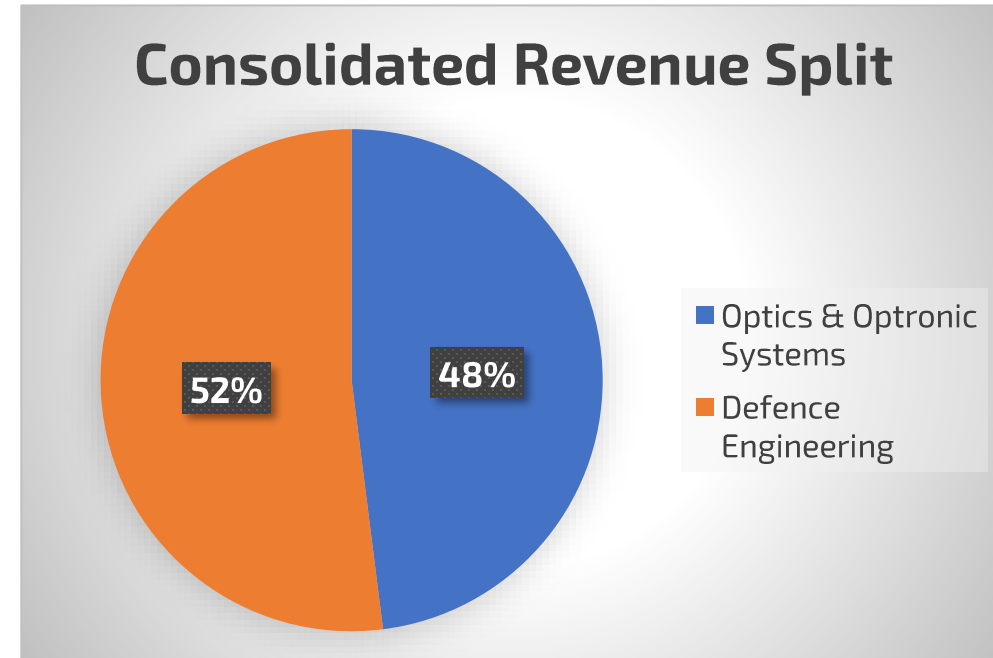
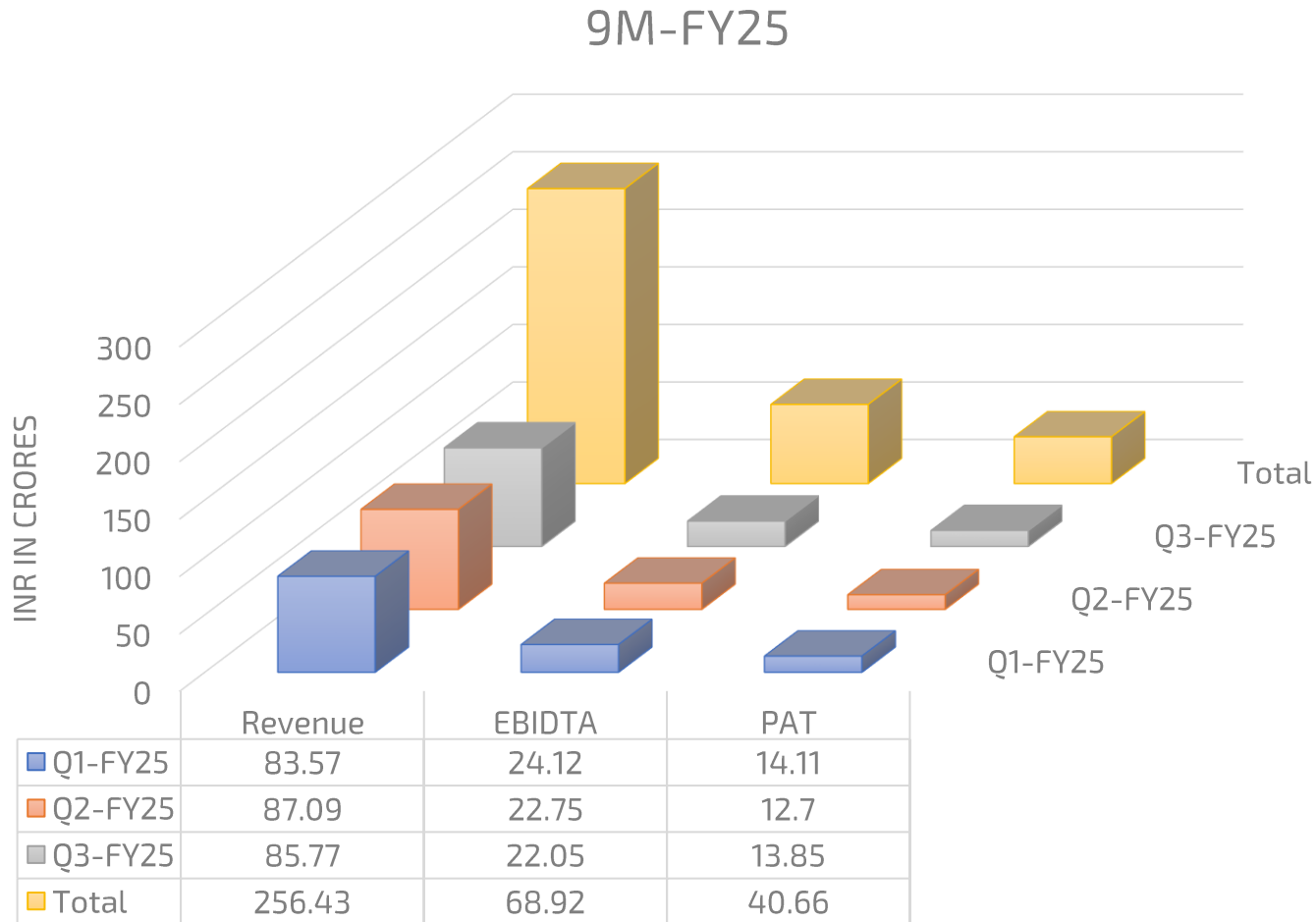

# Consolidated Order Book

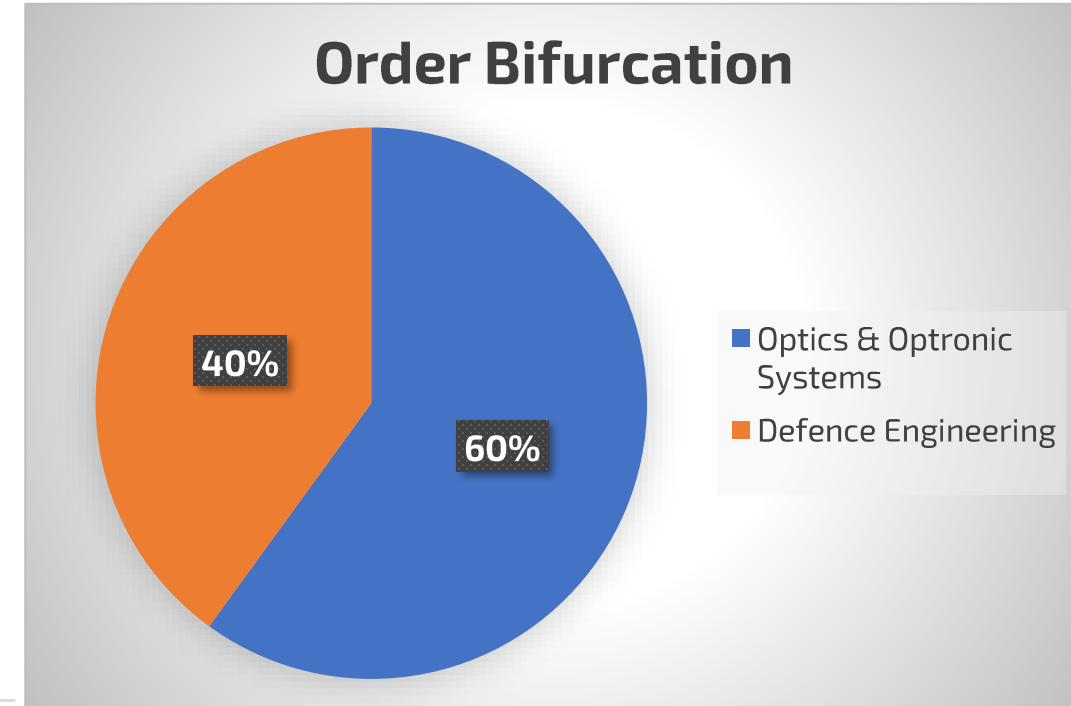
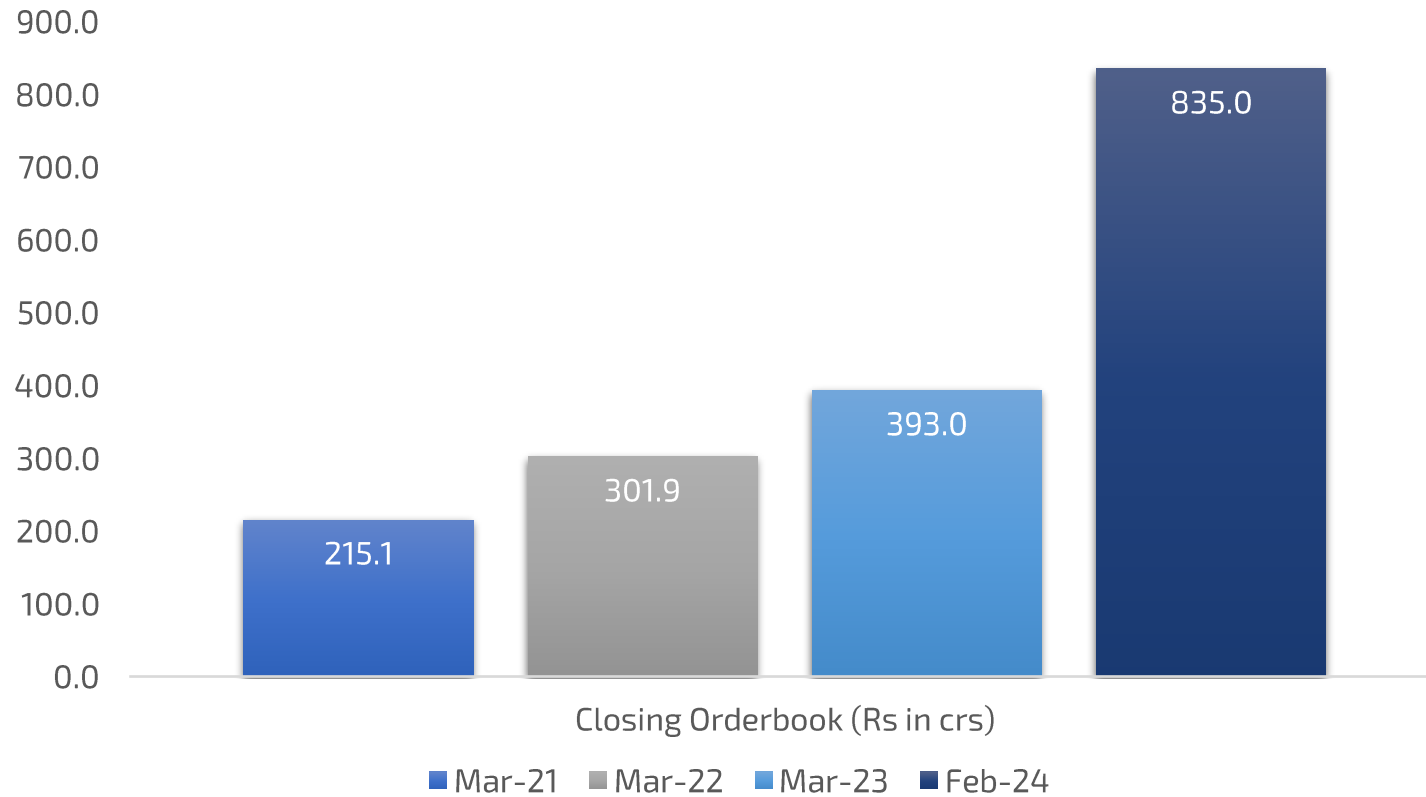

# High Value Opportunity Funnel – FY26

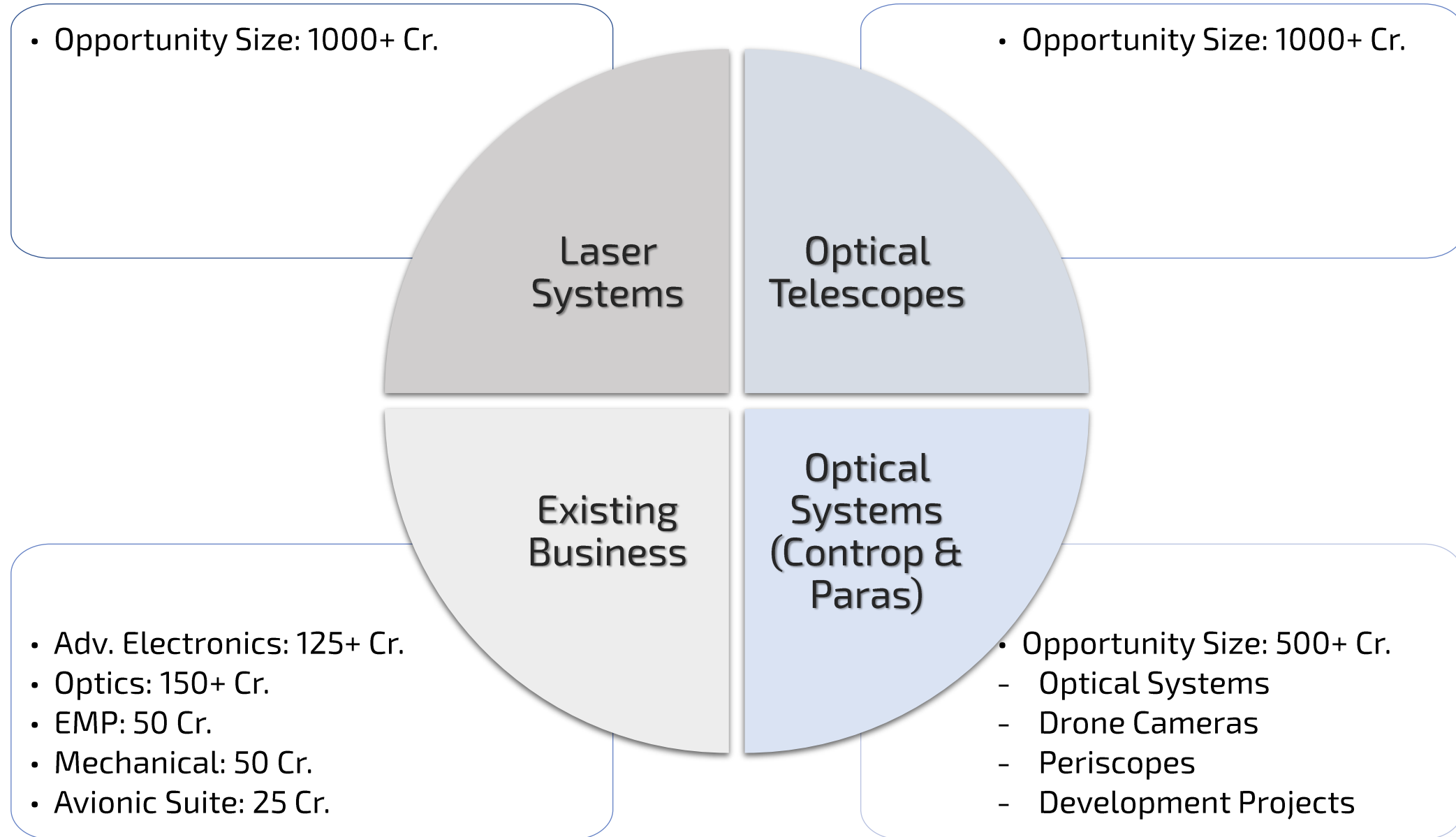



# High Value Opportunity Funnel – 1 to 5 Years

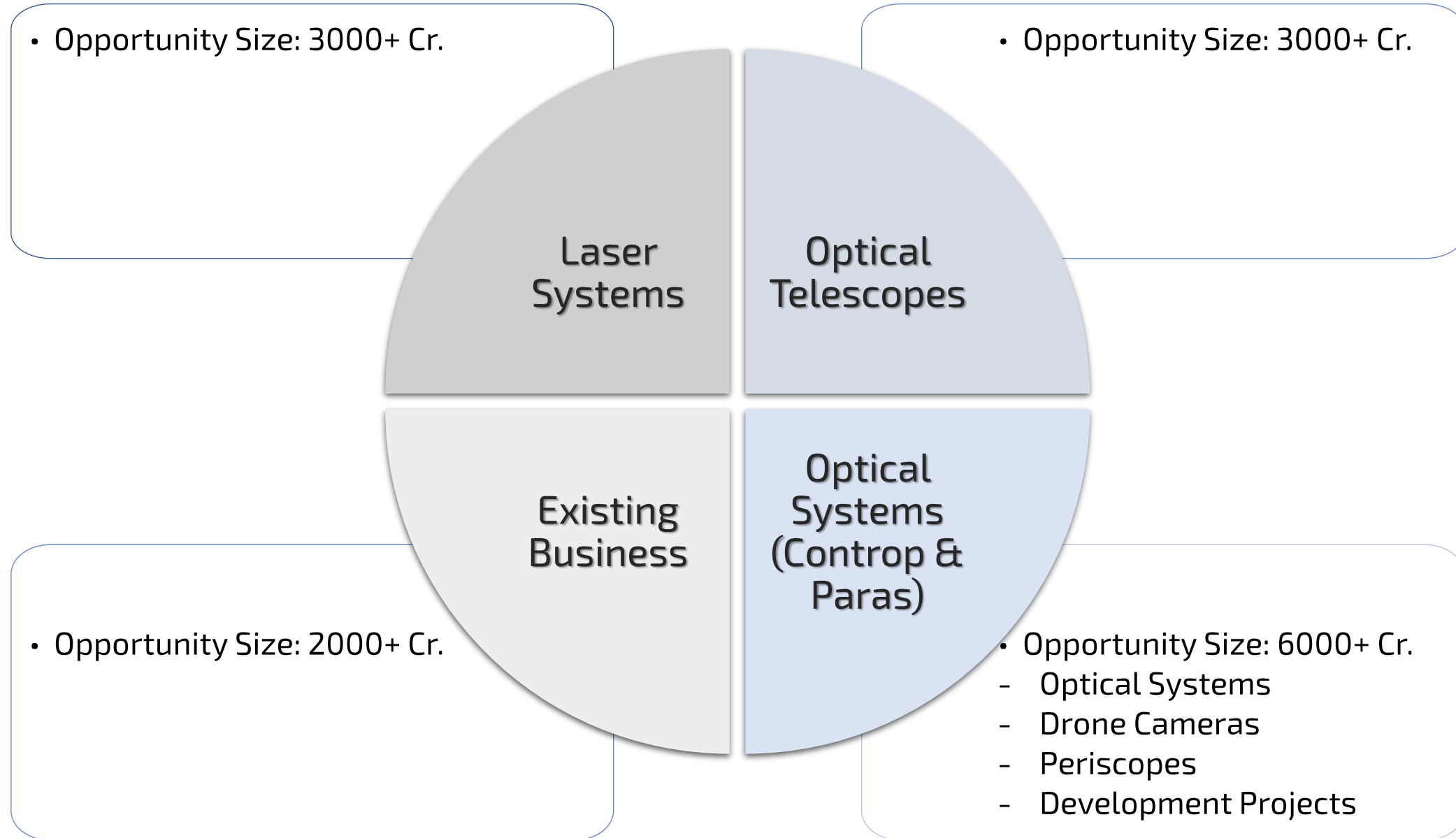



**Social Vision**

# Social Vision

## Empowered by Women

Paras has a very high percentage of Women team members and hence rather than Women Empowerment, we are empowered by Women

## Make A Difference

Paras Defence would like to positively make a difference to the social environment by offering employment.



## Nurturing for Bright Future

Paras offers opportunities to young talent and is always ready to give the 'Best in the Industry' career exposure to such young talent, which is the Bright Future of our Country.

## Make a Better Place

Paras Defence credits its success to its team and will strive to ensure conducive environment all its team members and social stake holders.



**Thank You**

[www.parasdefence.com](http://www.parasdefence.com) | [business@parasdefence.com](mailto:business@parasdefence.com)

