

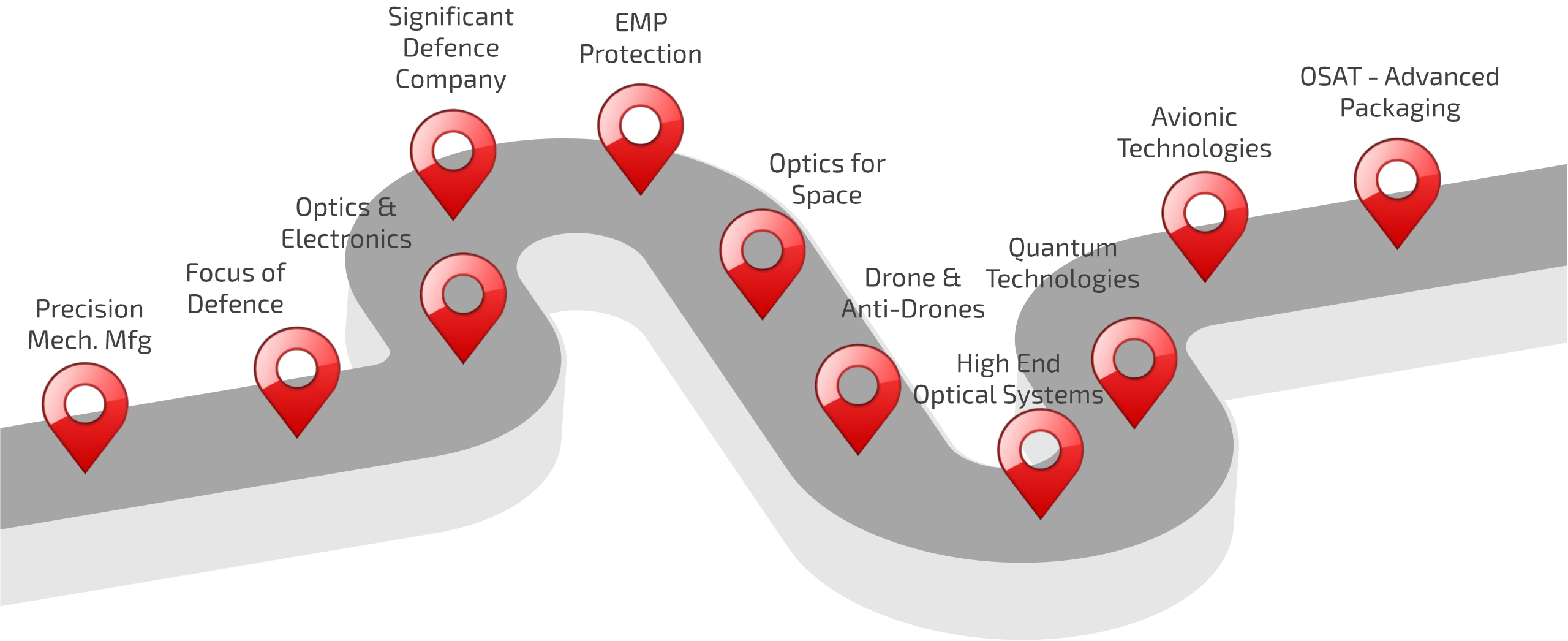

Paras Defence & Space Technologies Limited

Premier Defence and Space Engineering Company

Our Journey





Subsidiaries of Paras Defence

Paras Aerospace

Drones for Military, Industrial & Agricultural Applications
Drones Solutions

60%



MechTech Thermal

Thermal solutions for Space and Defence Applications

70%



Paras Heven Drones

Hydrogen Powered Drones for High Endurance Applications

51%



Paras Semiconductors

OSAT for Advanced Packaging Semiconductor Technologies

70%



55%



100%



100%



60%



Paras Anti-Drone

Radars & Radar Sub-Systems
Software Defined Radios
Phased Array Antennas
Anti-Drone Systems

Opel Technologies

Supply Chain solutions to Paras and Its customers

Quantico

Quantum Technology Development
Quantum Communication
Quantum Sensing

Paras Avionics

Air-to-Air Technologies
Aerospace Products & Solutions



India's No. 1 High-End Optical Systems Company

Paras aims to become India's No. 1 High-End Optical Systems Company catering to the Domestic as well as World Market, through in-house R&D & global partnerships.

India's No. 1 Laser Based Air Defence Company

Paras is in the process to offer turnkey Laser based Air Defence Solution and provide mitigation options against hostile drones and ariel targets. Coupled with other systems, we want to aim at providing all-round Air Defence Solutions.

India's No. 1 Anti-Drone Company

We strive to become India's No. 1 company developing and producing cutting-edge Anti-Drone Technologies including Radars, Software Defined Radios, Phased Arrays & Advanced Antennas etc.

India's No. 1 ElectroMagnetics Company

Paras aspires to offer turnkey solutions for ElectroMagnetic Protection covering EM Pulse, Anechoic Chambers & Antenna Test Ranges amongst others, not just for Domestic but for World Market

Leading Products



Submarine Periscope



Image only for application reference

Only Company in the whole Asia Pacific to develop and mfg. Submarine Periscope

World Class Proven Performance

Paras is delivering 1 Periscope every 3 Months and aiming for more...

Huge Opportunities on New as well as Existing Platforms with current funnel of 36+ Nos

Domestic & World Market opportunities indicate a yearly revenue of 200+ Cr.

Hyper-Spectral Cameras



Image only for application reference



Only Indian Pvt. Company to develop and mfg. a Hyper-Spectral Camera for Defence & Space

Will be jointly launched by DRDO & ISRO

100% Designed, Developed and Manufactured in India by Paras

Long term opportunities as these Cameras are a part of almost every Optical Space Mission

Hyper-Spectral Cameras will have varied applications incl. Defence, Medical, Agri etc.

ElectroMagnetic Protection Solutions



Image only for application reference

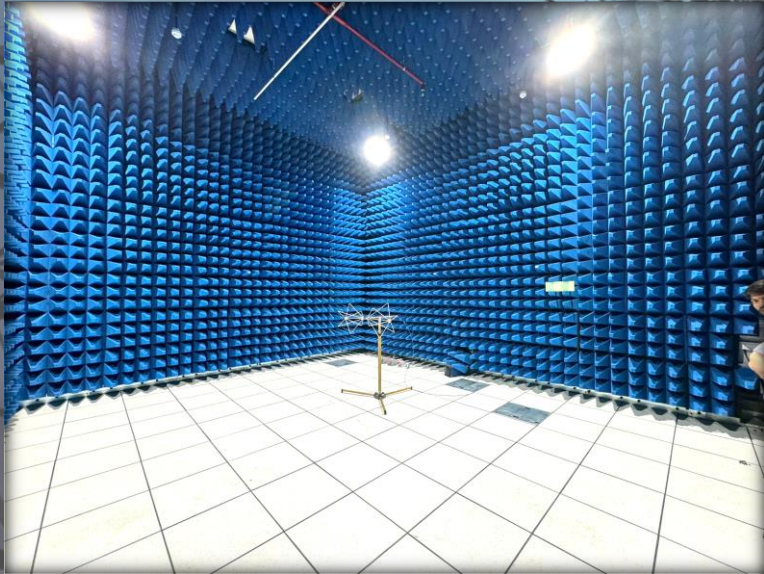

Only Indian Company to offer Turnkey ElectroMagnetic (EM) Protection Solutions

Certified & Field Proven High Performance against ElectroMagnetic Pulse (EMP) Threats

Turnkey Semi/Full Anechoic Chambers for EM Measurements along with ancillary services

Collaborated with Global Leader to offer High Performance Antenna Test Range Solutions

Huge Business Potential with Funnel of 350+ Cr. Over the next 2 to 3 Years

Border Defence System



First Indian Border Defence System to protect our frontline Soldiers from facing the firing

Rugged Field Tried System having Surveillance Unit, Weapon Unit & Control System

100% Design, Developed & Manufactured by Paras in collaboration with DRDO

Advanced trials in progress and performance is found satisfactory

Huge Domestic Business Potential of 4000 Nos. over the next 5 to 7 Years + Global Market

JV with Controp
Precision
Technologies
Ltd., Israel

World's leading
exclusive EO/IR
company



Paras has formed a JV with world's leading exclusive EO/IR company to manufacture world class EO/IR Systems in India (Under Make In India), for various platform including Drones.



JV Company of Controp Precision Technologies, Israel & Paras
Defence & Space Technologies Ltd., India

Optical Payloads for All Platforms

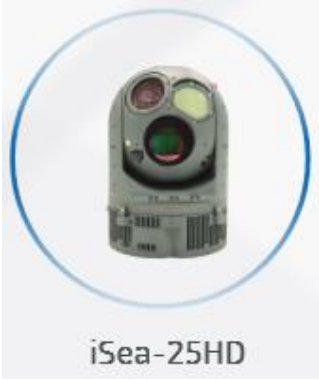

iSea-25HD

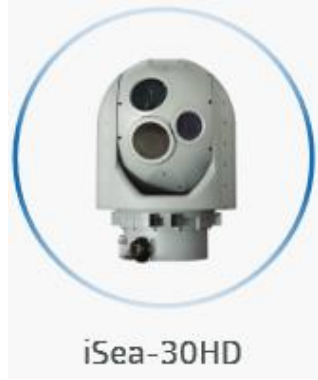

iSea-30HD



iSea-50HD



iSky-50HD



iSky-30HD



SIGHT-10E



SPEED-MR



SPEED-LR



SPEED-ER



TORNADO-ER



SIGHT-25E



SIGHT-25HD



M-STAMP

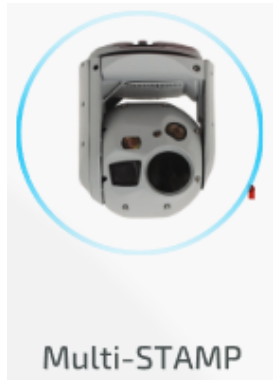

Multi-STAMP

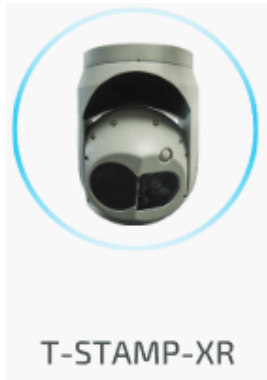

T-STAMP-XR



T-STAMP-XED



T-STAMP-XD



SIGHT-50HD

Optical Systems

Image only for application reference



Field Proven World Class EO/IR Optical Systems operational on various platforms worldwide

High Performance Stabilized Optical System

Day and Night Channels with precision Tracking & Laser Ranging for long distance targets

Extensive Funnel of over 5000 Units in the next 3 to 7 Years for only Sight – 25HD

Made in India, Made for the World

In Partnership with Controp Precision Technologies, Israel



One System, Many Opportunities



Armoured Vehicles
– BMP II



Air Defence Systems



FRCV



FICV



Light Armoured
Multipurpose Vehicle
(LAMV)



Sight-25HD



RCWS on MBT Arjun, BMP,
WAV

Estimated Opportunity Size of 6000+ Units over the next 3 to 5 Years

Cameras for Drones & UAVs



Image only for application reference

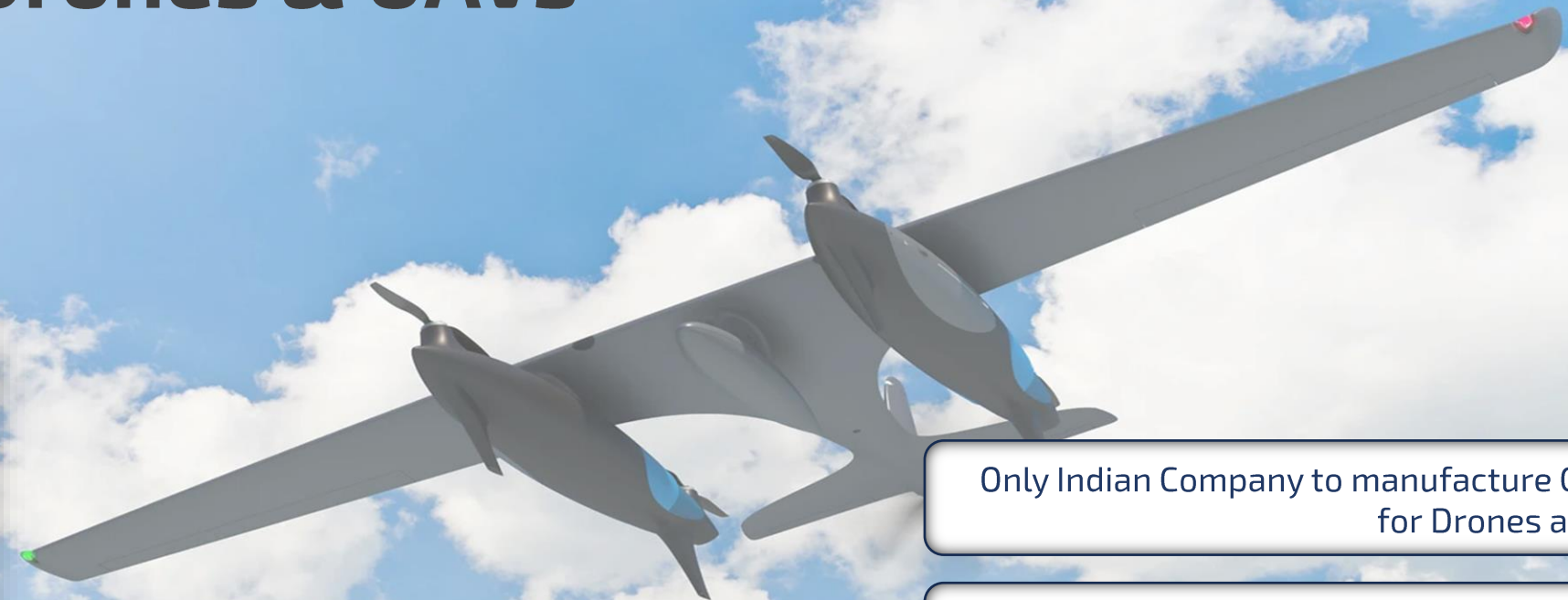

Only Indian Company to manufacture Cameras for Drones and UAVs

Exceptional Optical Performance with Un-cooled IR & Inertial Stabilization

Very Low Weight & Power Requirements making it suitable for multiple platforms

Made in India with very high Indigenous Content in collaboration with Microcon, Israel

High Domestic & Export Business Potential with growing Drone Market in India and the World

JV with Heven Drones, Israel



Paras has formed a JV with world's leading company for Hydrogen Powered Drones, to manufacture them in India (Under Make In India)

World's leading
company for Hydrogen
Powered Drones

Hydrogen Powered Drones

Image only for application reference



India's first Ready-to-Fly Hydrogen Powered Drones

Over 12Hrs of Flight Time with over 22Kgs of Payload

Offer exceptional advantages of High Energy Density, Fast Refueling, Quiet Operation etc.

Made in India with very high Indigenous Content in collaboration with Heven Drones, Israel

High Business Potential with constant need for High Flying Time with heavier Payloads

Hydrogen Powered Drones



Raider

Lift & Deliver

Payload Capacity: 22+ Kgs

Flight Endurance: 12+ Hrs

Max. Take-Off Weight: 118+ Kgs



H2D250

Compact & Tactical

Payload Capacity: 4.5+ Kgs

Flight Endurance: 10+ Hrs

Max. Take-Off Weight: 25 Kgs



H2D55

Endure the Heights

Payload Capacity: 4.5+ Kgs

Flight Endurance: 2+ Hrs

Max. Take-Off Weight: 30 Kgs

Inertial Navigation Systems



Full Range of Inertial Navigation Systems in partnership with Cielo, Israel

World Class, Field Proven, High Accuracy Performance

Customizable to User Requirements and can be alternate to legacy systems

Tested & Certified for Various Platforms for Land, Air, Naval, Submarine & Space

High Domestic Business Potential and Exceptional Export Potential



Applications for INS

Magnets for MRI Machines

Image only for application reference

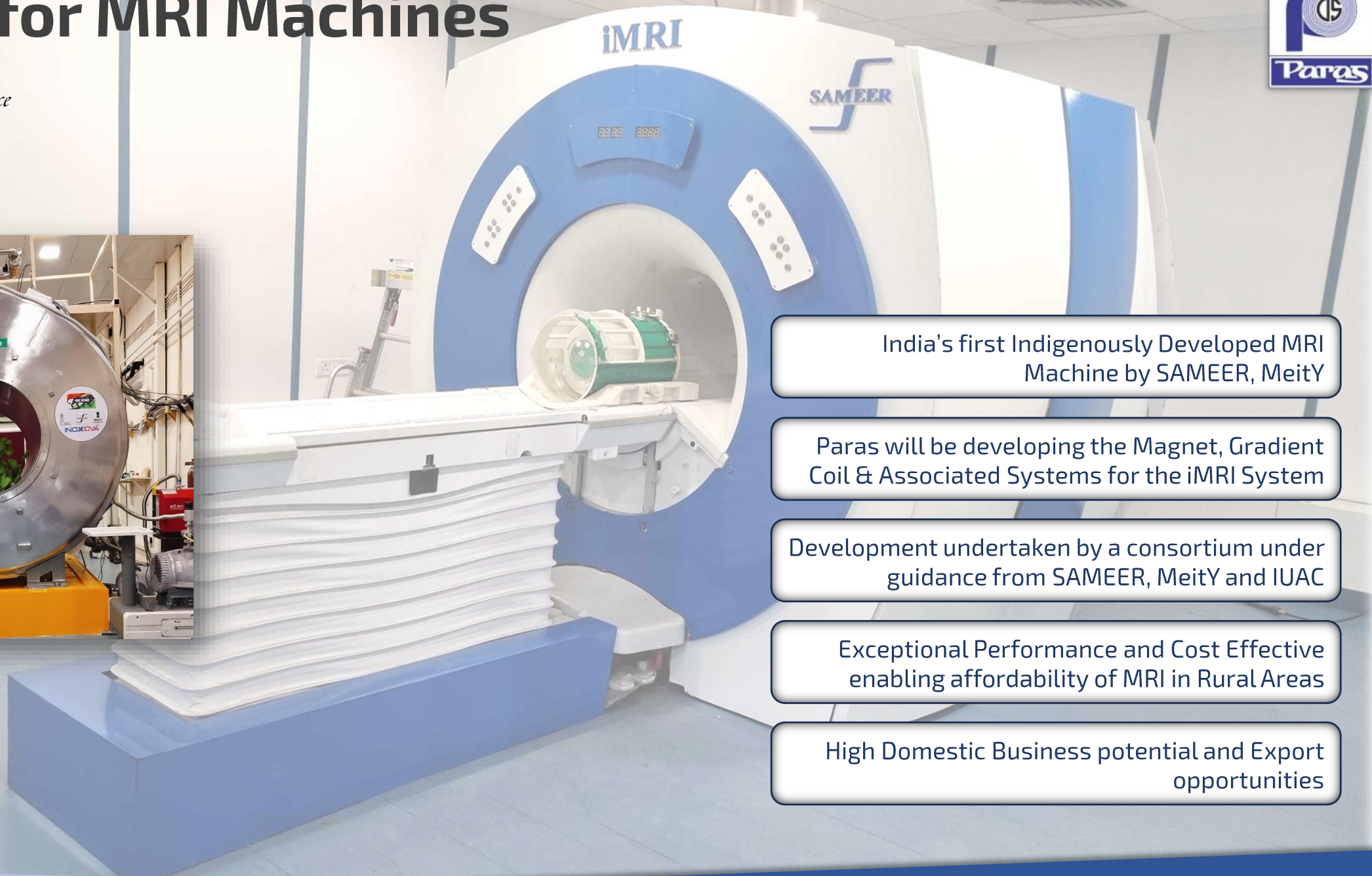

India's first Indigenously Developed MRI Machine by SAMEER, MeitY

Paras will be developing the Magnet, Gradient Coil & Associated Systems for the iMRI System

Development undertaken by a consortium under guidance from SAMEER, MeitY and IUAC

Exceptional Performance and Cost Effective enabling affordability of MRI in Rural Areas

High Domestic Business potential and Export opportunities

Avionic Suite for Saras – MK-II



Image only for application reference



Complete Glass Cockpit / Avionic Suite for Saras
– MK-II Aircraft Platform

Delivered 2 Shipsets and working with Customer
Closely for Project Completion

Aim to increase indigenous content in-line with
Make In India, for future requirements

Potential Business for Saras-MK-II estimated to
be 1+15+115 Nos in the next 5 to 7 Years

High Business Potential extending beyond
Saras-MK-II for various similar platforms

Revolutionary Products by our Subsidiaries

that may change the landscape of our Future



Flagship Anti-Drone Products



Dexter 20

All Integrated Drone Detection
& Jamming System

Range: 1.5+ KMs

All Integrated Drone Detection &
Jamming System

Frequency: 400MHz to 6GHz

Directional & Omnidirectional
Jamming

Adaptive IQ Waveform Jamming



Terminator

High Performance Drone
Jamming Gun/System

Range: 1.5+ KMs

High Performance Directional
Jamming System

Frequency: GPS L1, L2, L5, 2.4GHz,
5.2GHz, 5.8GHz

Plug & Play Modular Design

Man-Portable with Weight < 6Kgs

Range of Cutting-Edge Products



Hydra & Sky Sense
Drone Detection Systems



AeroBlast
Drone Jamming System



AirLink-DMR
Tactical Communication System

Winner of 4 iDex Challenges

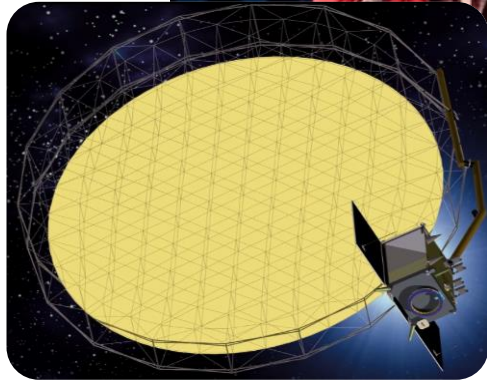

IAF Program: Design of SAR Radar
 TAM: 26.53 Bn\$
 (CAGR 10%)
 SOM : 30 Mn\$



Indian Army: Smart Anti Jamming systems
 TAM: 4.29 Bn\$
 (CAGR 12%)
 Potential: 40 Mn\$

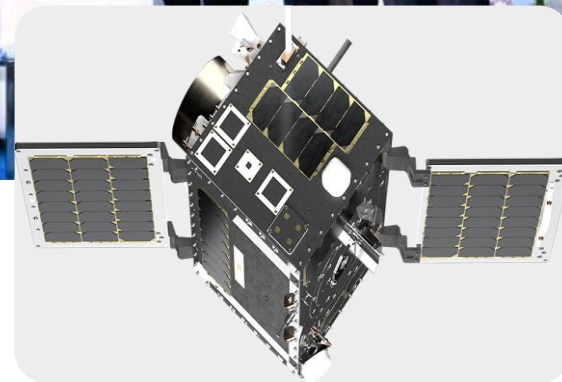

Indian Army: Smart Anti Jamming systems
 TAM: 4.29 Bn\$
 (CAGR 12%)
 Potential: 40 Mn\$

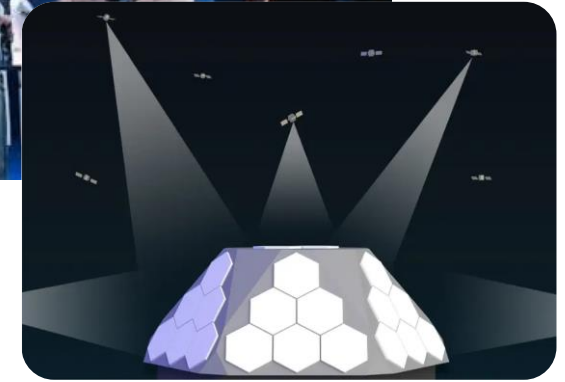

DSA: Mobile Ground Station for Satellite
 TAM: 60.7 Bn\$
 (CAGR 12.8%)
 Potential: 60 Mn\$

Developments in Paras Anti-Drone



Image only for application reference

RF & Microwave Custom Developments

Advanced Phased Arrays

Next Generation Software Defined Radio

Complex Antenna Systems

Futuristic Counter UAV Technologies

World of Opportunities





**Optical Systems for
AeroSpace Programs**



**Solutions for Air
Defence Applications**



Future Technologies

AeroSpace Programs





Recent Updates on Opportunities in Space

EDITION IN ▾ MUMBAI 30°C

THE TIMES OF INDIA

India Saving Our Stripes Times Evoke Maharashtra Delhi Karnataka Tamil Nadu Telangana ...

NEWS / INDIA NEWS / CCS 'Approves Launch Of 52 Spy Satellites For...

TRENDING Mahadev Betting App Owner Goa Weather Ajit Pawar New UPI Transac < >

CCS 'approves launch of 52 spy satellites for Rs 27,000 crore to boost space surveillance

Surendra Singh / TNN / Oct 12, 2024, 01:20 IST SHARE FOLLOW US

Paras Defence is the Only Indian Private Company which has all-round capability for Design, System Engineering, Manufacturing, Integrate, Test & Space Qualify Optical Systems for Space Programs and is working towards having significant workshare in the above!

The screenshot shows a news article from Hindustan Times. The headline reads "Exclusive: CCS clears launch of 52 surveillance satellites". The author is Shishir Gupta. The article is dated Oct 11, 2024, 08:32 AM IST. The page includes navigation links for "2024 US Elections", "Crickit", "HT Premium", and "Loan ₹10 Lakh". There are also social media sharing icons for Facebook, X, and LinkedIn, along with a "Festival of Gifts" badge.

Space Programs



Image only for application reference

Complete Optical Missions for Space

High Resolution Hyperspectral Camera for ISRO,
Pvt. Companies & Export

Sub-Meter Resolution Optical Camera

Optical Payloads for Oceanography

Optical Payloads for Resource Management

Optical Payloads for Space Defence

Ground to Space Telescopes for Space Debris
Monitoring

Space to Space Surveillance Missions

Free Space Optical Communication from Gnd to
Space and Space to Space

Optical Payloads for Interplanetary Missions

Airborne Optical Systems



Image only for application reference

Developing Advanced Optical Systems for Airborne Applications with our Customers

IRST – Infra-Red Search & Tracking System

Optical Camera Systems for Combat Aircrafts

High Performance Optical Systems for Medium/High Altitude Drones

Paras aims to become India's first company to develop and mfg. High End Airborne Payloads

Solutions for Air Defence Applications



EO/IR Systems

EW Systems

High Power Laser Systems

C4I - Command & Control Systems

High Power EM Systems

High Power Laser Systems

Image only for application reference

First
Company
in India



High Power Laser defence against Hostile Aerial Platforms such as Drones, Missiles & Aircrafts

Ground to Air and Ground to Space Applications

Air to Air and Space to Space Applications

Designed, Developed & Manufactured in India with High Efficient Optical Design by Paras

Addressable Market of approx. 25000 Crores

Laser Systems for Various Applications

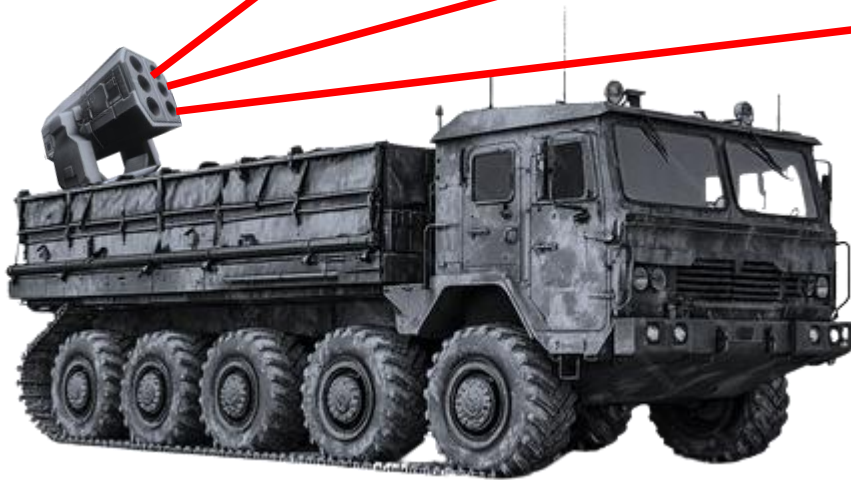

First
Company
in India

Future Technologies



Quantum Technologies



Image only for application reference

Tread in Quantum Communications & Quantum Sensing

Prowess in Design of Optical & Electronic Systems complements Quantum Technologies

Currently building team and technologies as our first steps into Quantum World

Near-term to Mid-term Opportunities in the area of Quantum Sensing

Mid-term to Long-term Opportunities in the area of Quantum Communication

Avionics Technologies



World Class, Cutting Edge Technologies in
Military Aviation

Collaborate to provide Avionic Solutions like Air-
to-Air Refueling Systems amongst others

Indigenous Manufacturing of Certified Systems
with Local Installation & After Sales Support



Image only for application reference

Wide Range of Technologies from Components
to Turnkey Solutions

High value business potential of critical Aviation
Technologies, which lack local support today

OSAT for Advanced Packaging



Image only for application reference

Setting up a state-of-the-art Advanced Heterogeneous Packaging (OSAT)

Supports Chiplet & System-Level Integration while complementing India's Design Ecosystem

Focused on Defence, High-Performance Computing (HPC), Networking etc. Applications

Domestic hub for chiplet integration and advanced system-in-package (SiP) technologies

Export-Grade OSAT services that meet International Standards

OSAT – Outsourced Semiconductor Assembly & Testing



PARAS DEFENCE
& SPACE TECHNOLOGIES LTD.

About Us

Looking at a brighter Tomorrow

Company at a Glance



**Wide Range
of Products**



**Strong Team
of 600+**



**World Class
Quality**



**Innovation &
R&D Centric**



**World Class
Manufacturing
Setup**



**Heritage of
Defence &
Space
Programs**

Exceptional Capabilities

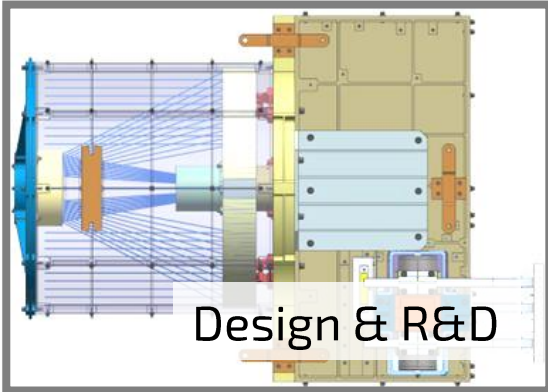

Design & R&D



Manufacturing



Integration



Test & Validation

- Optronic System Design
- Opto-Mech. Design
- Optical Design
- Electronic System Design
- Embedded System Design
- Electronic H/W Design
- Software Development
- ElectroMagnetic Design
- RF/Microwave Design
- Antenna Design
- Mechanical Design

- Infra-Red Lenses
- Optical Mirrors
- Optical Domes
- Optical Gratings
- Flowformed Tubes
- Titanium Assemblies
- Mech. Racks & Consoles
- Cold Plates
- Doors & Hatches
- Airvents & Waveguides
- Wiring Harnesses

- Submarine Periscope
- Border Defence Systems
- Hyper-Spectral Cameras
- Optical Systems
- Command/Control Consoles
- Control Systems
- High Performance PCs
- Rugged Displays
- Anti-Drone Systems
- Software Defined Radios
- Antenna Systems

- Physical Metrology
- Optical Metrology
- MTF Test Setup
- Electronic Test Setup
- Electrical Test Setup
- Environmental Test Setup
- High Pressure Test Setup
- Design Validation Tools
- RF Test Setup
- Antenna Test Setup
- Electromagnetic Test Setup

Management Team

Board of Directors



Sharad Shah
Chairman



Munjal Shah
Managing Director



Shilpa Mahajan
Director

Independent Directors & Company Secretary



M.M. Handa
Independent Director



Dr. Hina Gokhale
Independent Director

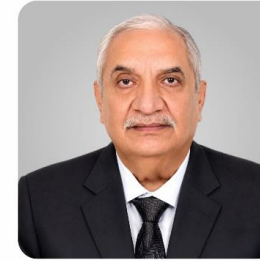

Suresh Katyal
Independent Director



Minal Bhatte
Company Secretary



Anish Mehta
Director: Bus. Dev.



Harsh Bhansali
CFO



Amit Mahajan
Director: Tech. & R&D



Ami Shah
V.P. HR

Management Team

India's Best Optics Team



Krishna Murthy
Ex-ISRO



MV Rajashekhar
Ex-BEL



Bharat Yelkur
Sr. Vice President



S. Somashaker
Ex-ISRO



R. Rajagopal
Sr. Vice President



N. Saravanan
Sr. Vice President

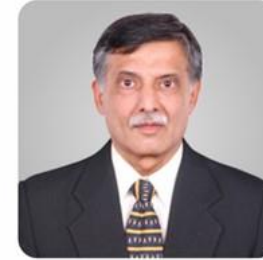

K. Natarajan
Sr. Vice President



Dr. Padmanabham
Ex-BDL

Vice Presidents



G.S. Ravichandar
Ex-BEL



D. Ramakantha
Ex-BEL



A.R. Bodhe
Industry Expert



Yellamanda Y
Ex-BEL



Locations



Sales & Marketing, Customer Interface, Post Sales Co-ordination

New Delhi

Heavy Engineering Mfg., Mechanical System Integration, Test Facilities

Ambernath

Navi Mumbai

Sales & Marketing, Customer Interface, Post Sales Support

Hyderabad

Optics Mfg, Opto-Mech Integration, Electronics D&E, System Integration, Directors & Corporate Departments

Bengaluru

Optics Design, Advanced Electronics System Design, Sales & Marketing, Projects & Customer Interface, After Sales Support

Prestigious Customers



Govt. Customers



Indian Ordnance Factories



Defence R&D Organisation



Bharat Electronics



ISRO



Goa Shipyard Limited



Mazagon Dock Limited



Hindustan Shipyard Limited



Garden Reach Shipbuilders & Engineers Ltd.



Cochin Shipyard Limited



BrahMos Aerospace Pvt. Ltd.



Bharat Dynamics Ltd.



Department of Atomic Energy



Electronics Corporation of India Ltd.

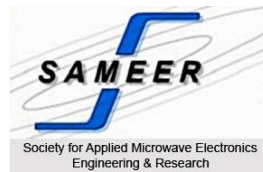

Society for Applied Microwave Electronics Engineering & Research



National Aerospace Laboratory



National Physical Laboratory of India



Indian Institute of Astrophysics



Hindustan Aeronautics Ltd.

Private Customers



Godrej & Boyce Mfg. Co. Ltd.



Tata Power



Larsen & Toubro



Tata Consultancy Services



Alpha Design Technologies Pvt. Ltd.



Astra Rafael Comsys Pvt. Ltd.



Solar Industries India Ltd.



Premier Explosives Ltd.



Tonbo Imaging

International Customers



Rafael Advanced Defense
Systems Ltd.



Israel Aerospace Industries



Elbit Systems



Controp



Tae Young Optics Co. Ltd.



Chaban Group

Financial Overview



Consolidated FY26 Financial Performance

Revenue from Operations

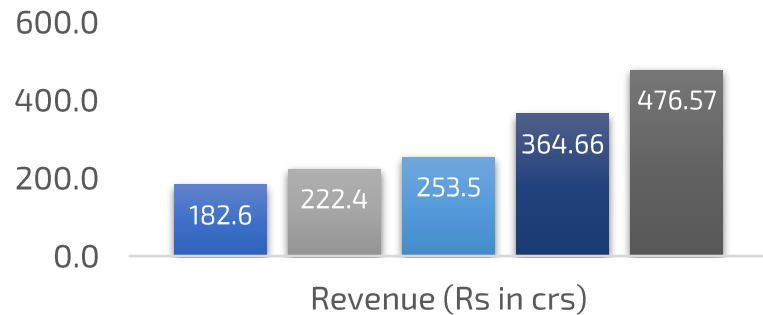

■ FY 21-22 ■ FY 22-23 ■ FY 23-24
 ■ FY 24-25 ■ FY 25-26

EBITDA

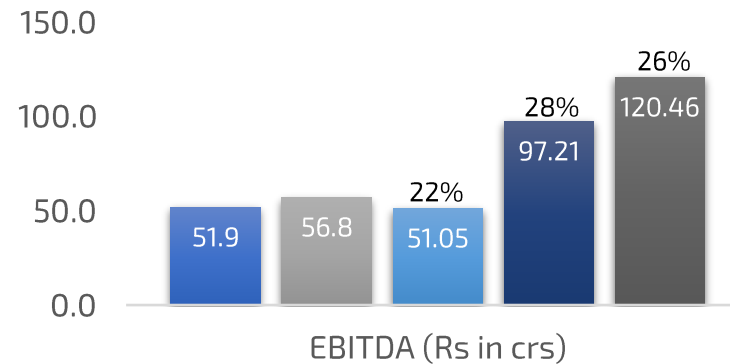

■ FY 21-22 ■ FY 22-23 ■ FY 23-24
 ■ FY 24-25 ■ FY 25-26

Profit after Tax

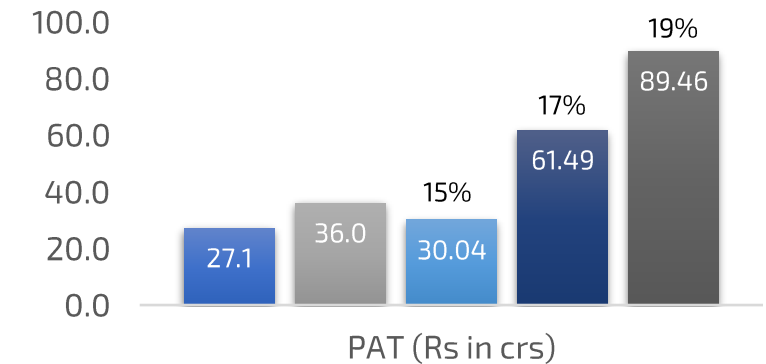

■ FY 21-22 ■ FY 22-23 ■ FY 23-24
 ■ FY 24-25 ■ FY 25-26

Guidance for FY27 & FY28:

We aim to grow our revenues by 30 – 40 % and maintain or slightly better our profitability as compared to previous years.

Q4-FY26 Financial Performance

Q4-FY26

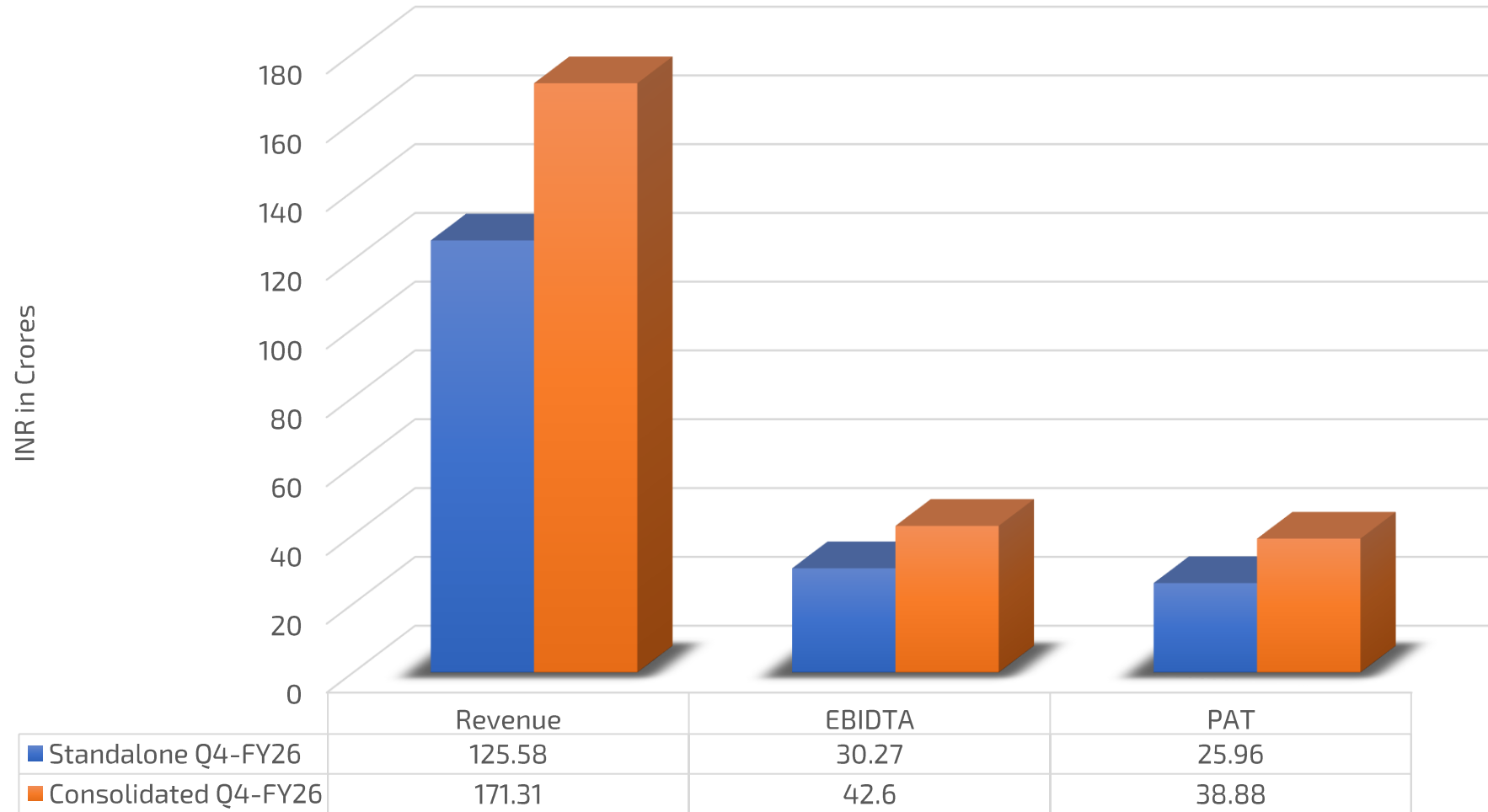

Consolidated Revenue Split

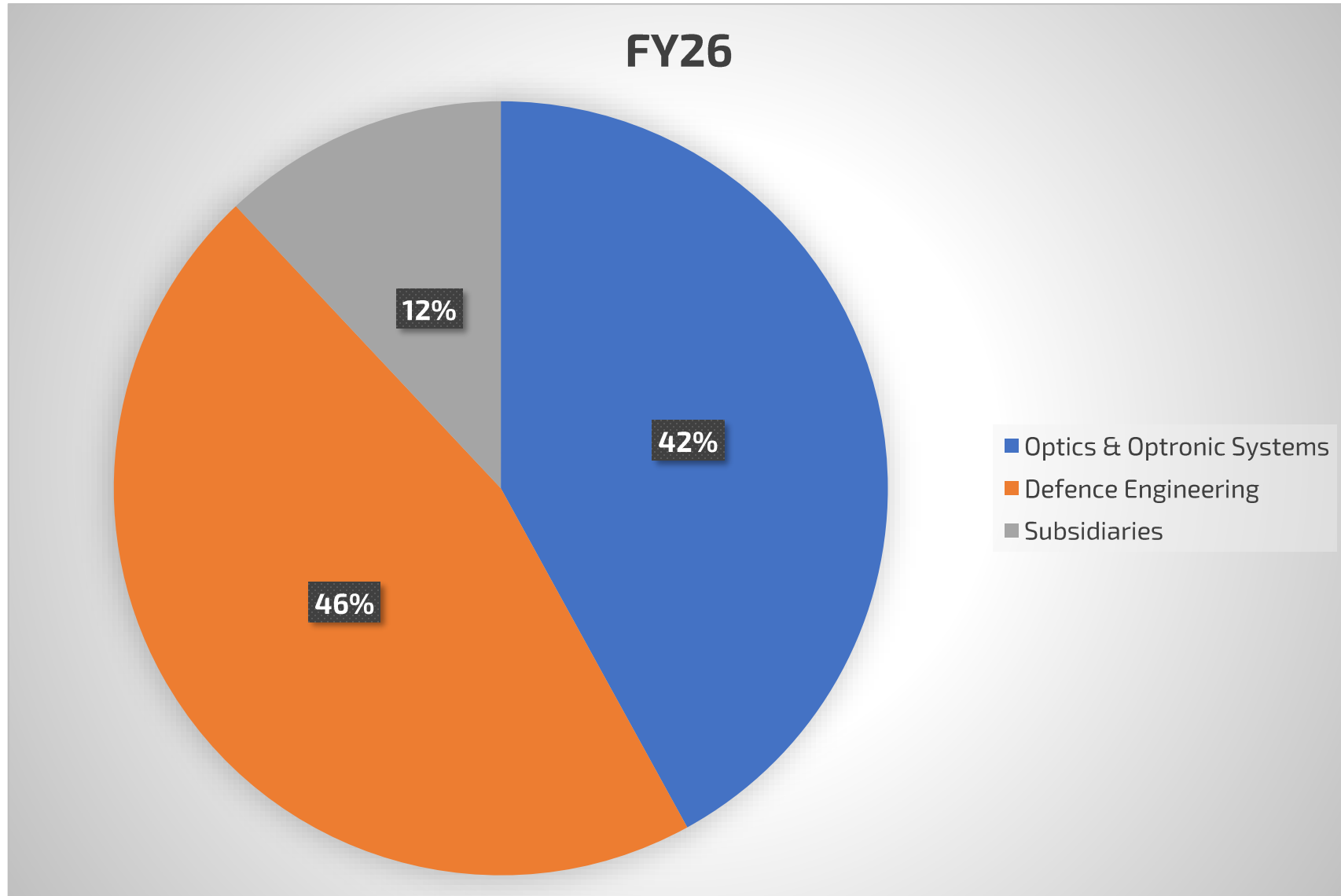

Consolidated Order Book

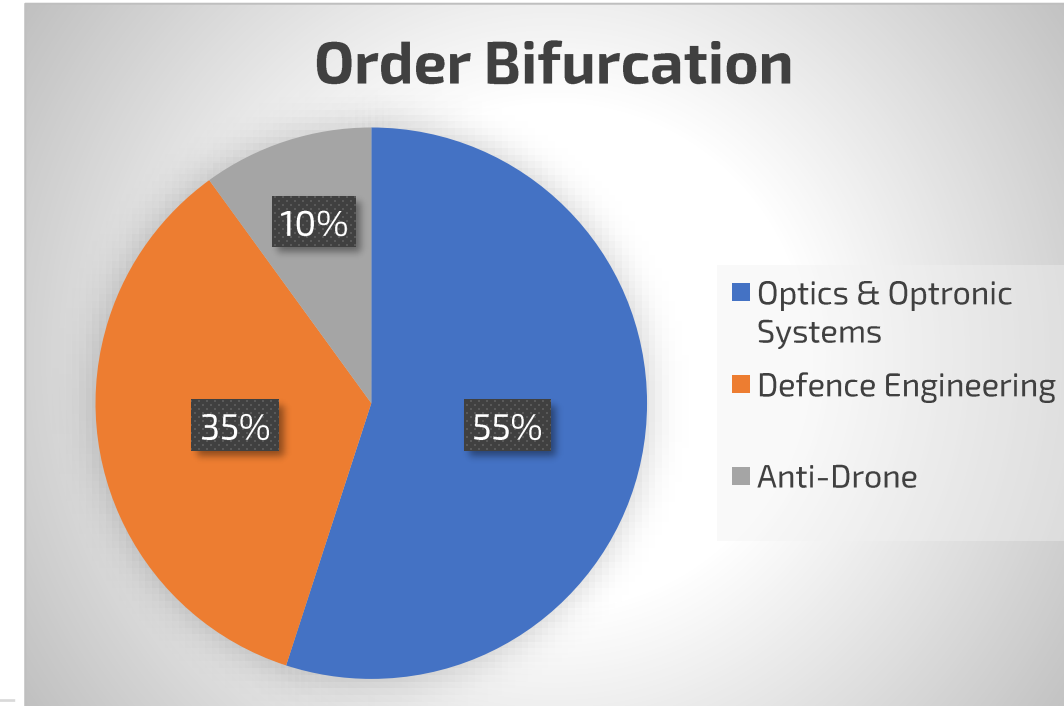
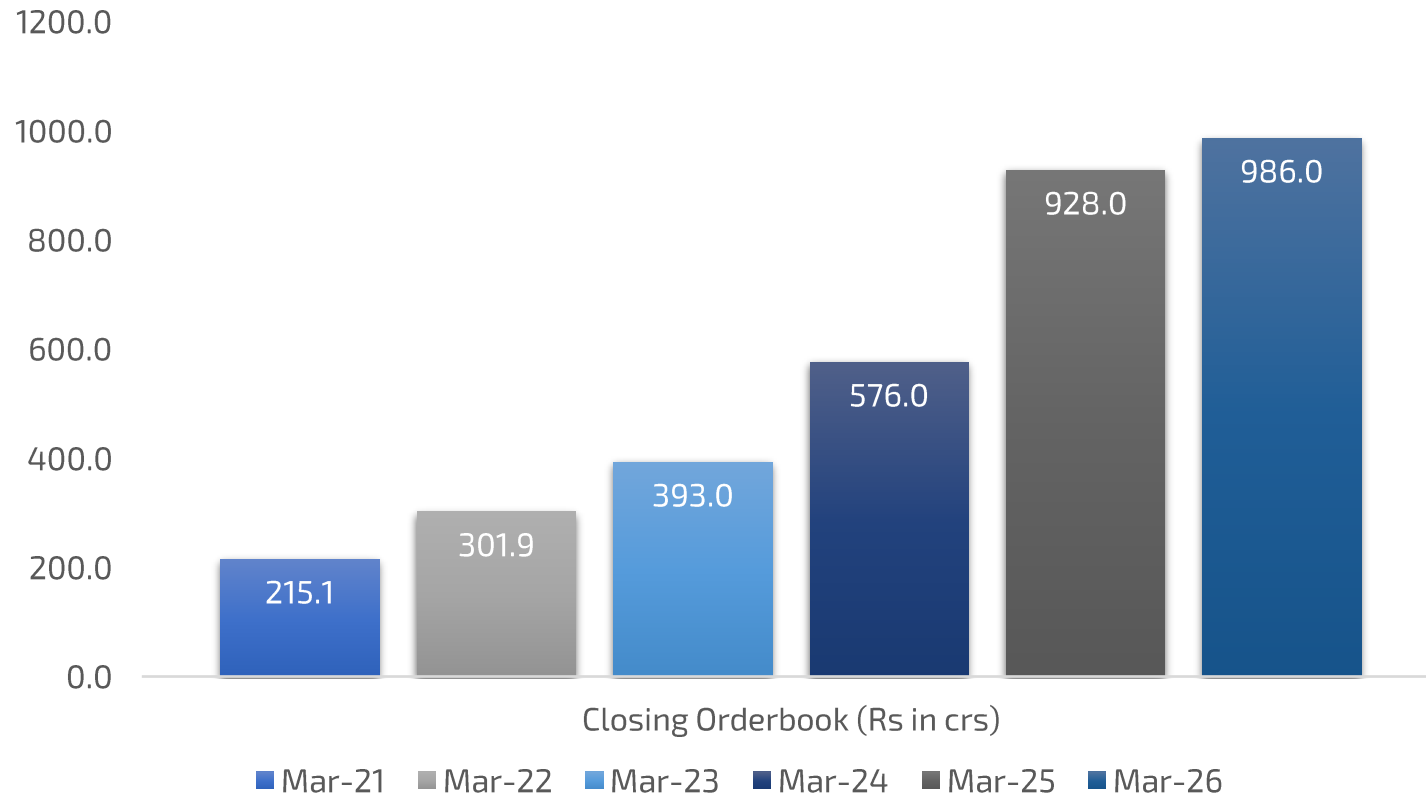



Social Vision

Empowered by Women

Paras has a very high percentage of Women team members and hence rather than Women Empowerment, we are empowered by Women

Make A Difference

Paras Defence would like to positively make a difference to the social environment by offering employment.



Nurturing for Bright Future

Paras offers opportunities to young talent and is always ready to give the 'Best in the Industry' career exposure to such young talent, which is the Bright Future of our Country.

Make a Better Place

Paras Defence credits its success to its team and will strive to ensure conducive environment all its team members and social stake holders.



Thank You

www.parasdefence.com | business@parasdefence.com

